

ANBAUANLEITUNG

mounting instructions • instructions de montage • instrucciones de montaje • istruzioni di montaggio

FBL.01.529.20000

beinhaltet • contains • contient • contiene • contiene

FBL.01.529.10000

FSC.01.529.10000

Art.-Nr.: FBL.01.529.10000

Revision: 00 · Datum: 09 - 2023

Fußbremshebel

 ~ 1 h.LEICHT     SCHWER

DEUTSCH - Vielen Dank, dass Sie sich für dieses Premium-Produkt von SW-MOTECH entschieden haben. Besuchen Sie unseren Webshop für weitere Informationen (z. B. Modellzuweisungen). Erforderliche Dokumente (z. B. ABE) stehen Ihnen dort als Download zur Verfügung.

Bitte lesen und verstehen Sie alle Anweisungen, Sicherheitshinweise und Warnungen in dieser Anbauanleitung vor Montage und Nutzung des Produkts, um Verletzungen und Schäden zu vermeiden. Bewahren Sie diese Anbauanleitung als Referenz auf.

Dieses Produkt wurde für Fahrzeuge im Werkzustand entwickelt. Die Kompatibilität mit Original-Zubehörteilen bzw. den Zubehörteilen anderer Hersteller kann nicht gewährleistet werden.

Diese Anbauanleitung ist nach unserem derzeitigen Kenntnisstand verfasst worden. Rechtliche Ansprüche auf Richtigkeit bestehen nicht. Fehler und Irrtümer vorbehalten. Technische und gestalterische Änderungen sind vorbehalten. Das Urheberrecht liegt bei SW-MOTECH.

SICHERHEITSWARNUNGSSYMBOL

 Dieses Warnsymbol wird in dieser Anbauanleitung verwendet, um vor tödlichen Gefahren, Verletzungen oder anderen Gefahren zu warnen. Die Wörter **GEFAHR**, **WARNUNG** oder **VORSICHT** werden mit diesem Warnsymbol verwendet, um wichtige Sicherheitshinweise und Informationen in Bezug auf die Montage und Nutzung dieses Produkts zu übermitteln. Diese Wörter zusammen mit dem Sicherheitswarnsymbol bedeuten:

▲ GEFAHR: Weist auf eine gefährliche Situation hin, die zum Tod oder zu schweren Verletzungen führt, wenn sie nicht vermieden wird!

▲ WARNUNG: Weist auf eine gefährliche Situation hin, die zum Tod oder zu schweren Verletzungen führen kann, wenn sie nicht vermieden wird!

▲ VORSICHT: Weist auf eine gefährliche Situation hin, die zu leichten oder mittelschweren Verletzungen führen kann, wenn sie nicht vermieden wird!

▲ HINWEIS: Wichtige Informationen, jedoch nicht in Bezug auf Todes- oder Verletzungsgefahr (nur Sachschäden)!

ALLGEMEINE HINWEISE

▲ WARNUNG: Die Montage und/oder Wartung dieses Produkts erfordert fortgeschrittene technische Fähigkeiten, geeignetes Werkzeug und ein gutes Verständnis der Werkzeugnutzung und Drehmomentangaben. Zu Ihrer eigenen Sicherheit empfiehlt SW-MOTECH, die Montage und/oder Wartung von einer qualifizierten und zertifizierten Zweiradwerkstatt durchführen zu lassen.

▲ WARNUNG: Wenn Sie sich für die Eigenmontage dieses Produkts entscheiden, lesen Sie vor Montage und Nutzung die Anbauanleitung sorgfältig und vollständig durch und befolgen Sie alle Anweisungen, um schwere oder tödliche Verletzungen zu vermeiden. Beachten Sie bei der Montage und Verwendung auch alle relevanten Informationen im Fahrzeughandbuch. **WENN SIE EINEN TEIL DIESER ANBAUANLEITUNG NICHT VERSTEHEN ODER EINE ERKLÄRUNG EINER ANWEISUNG BENÖTIGEN, VERSUCHEN SIE NICHT DIESES PRODUKT ZU MONTIEREN, OHNE SW-MOTECH UM HILFE ZU FRAGEN!**

VORBEREITUNG: Lesen Sie die Anbauanleitung aufmerksam und stellen Sie sicher, dass alle Teile der Stückliste vorhanden sind.

▲ VORSICHT: Achten Sie auf den sicheren Stand Ihres Fahrzeugs. Schalten Sie den Motor ab und ziehen Sie den Zündschlüssel. Lassen Sie den Motor/Auspuff bei Bedarf abkühlen. Klemmen Sie die Batterie bei Arbeiten an der Elektrik ab. Verwenden Sie nur geeignetes Werkzeug und tragen Sie während der Montage und Wartung immer eine Schutzbrille und Handschuhe. Lassen Sie sich bei der Montage und Wartung von einer zweiten Person helfen.

MONTAGE: Alle vom Fahrzeug entfernten Teile und Verbindungen müssen gemäß den Angaben des Fahrzeugherstellers wieder eingebaut oder durch von SW-MOTECH gelieferte Teile und Hardware ersetzt werden.

▲ WARNUNG: Sichern Sie alle Gewinde, sofern nicht anders angegeben, mit mittelstarker, flüssiger Schraubensicherung.

▲ GEFAHR: Von SW-MOTECH nicht definierte Anzugsdrehmomente müssen Sie vom Fahrzeughersteller oder von einer zertifizierten Motorradwerkstatt beziehen.

FUNKTIONSKONTROLLE: Stellen Sie nach der Montage sicher, dass keine beweglichen Teile blockiert sind und die Funktion des Fahrzeugs nicht gestört wird. Kabel und Schläuche dürfen nicht scheuern und/oder geklemmt werden.

▲ WARNUNG: Führen Sie vor Fahrtbeginn eine umfassende Funktionskontrolle durch. Prüfen Sie nach den ersten 50 km und dann regelmäßig das Anzugsmoment aller Verbindungen und den festen Sitz des Produkts. Montiertes Zubehör kann das Fahrverhalten und die Stabilität des Fahrzeugs verändern.



SW-MOTECH GmbH & Co. KG
Ernteweg 7-10
35282 Rauschenberg
Deutschland



info@sw-motech.com
www.sw-motech.com



Beachten Sie in dem Abschnitt MONTAGE vorkommenden Symbole und deren Bedeutung. Wenn im Abschnitt MONTAGE die Bezeichnung OEM vorkommt, müssten die Vorgaben des Fahrzeugherstellers beachtet und angewandt werden.



Bei Fragen steht Ihnen unser Kundendienst sowie unsere Distributoren gerne zur Verfügung. Unsere Telefonnummer sowie eine Liste unserer Distributoren finden Sie in unserem Webshop: www.sw-motech.com



Schraubensicherung verwenden: Weist darauf hin, dass ein Gewinde mit flüssiger Schraubensicherung bestrichen werden muss. H (HIGH): hohe Festigkeit; M (MEDIUM): mittlere Festigkeit; L (LOW): niedrige Festigkeit.



Anziehen / Anzugsmomentangabe beachten: Weist auf das von SW-MOTECH bzw. vom Fahrzeughersteller (OEM) vorgegebene Anzugsmoment eines Teils hin.



Keine Schraubensicherung verwenden: Weist darauf hin, dass an der Stelle keine flüssige Schraubensicherung notwendig ist.

STÜCKLISTE - ANBAUANLEITUNG LESEN UND AUFBEWAHREN!

4

1



FBL.01.529.900.01.02

 1/1

2



FBL.01.529.003.03

 1/1

3



FBL.01.529.004.03

 1/1

4



M4 x 8; ISO 7380
SC.ST.04.008.02.73800.109

 4/4

6

5



SP.ST.020.016.01.94

 1/1

7

6



FBL.00.127.003.36

 1/1

7



M6 x 50; DIN 912
SC.ST.06.050.01.912.088

 1/1

8



M6; DIN 985
MU.ST.06.01.985.08

 1/1

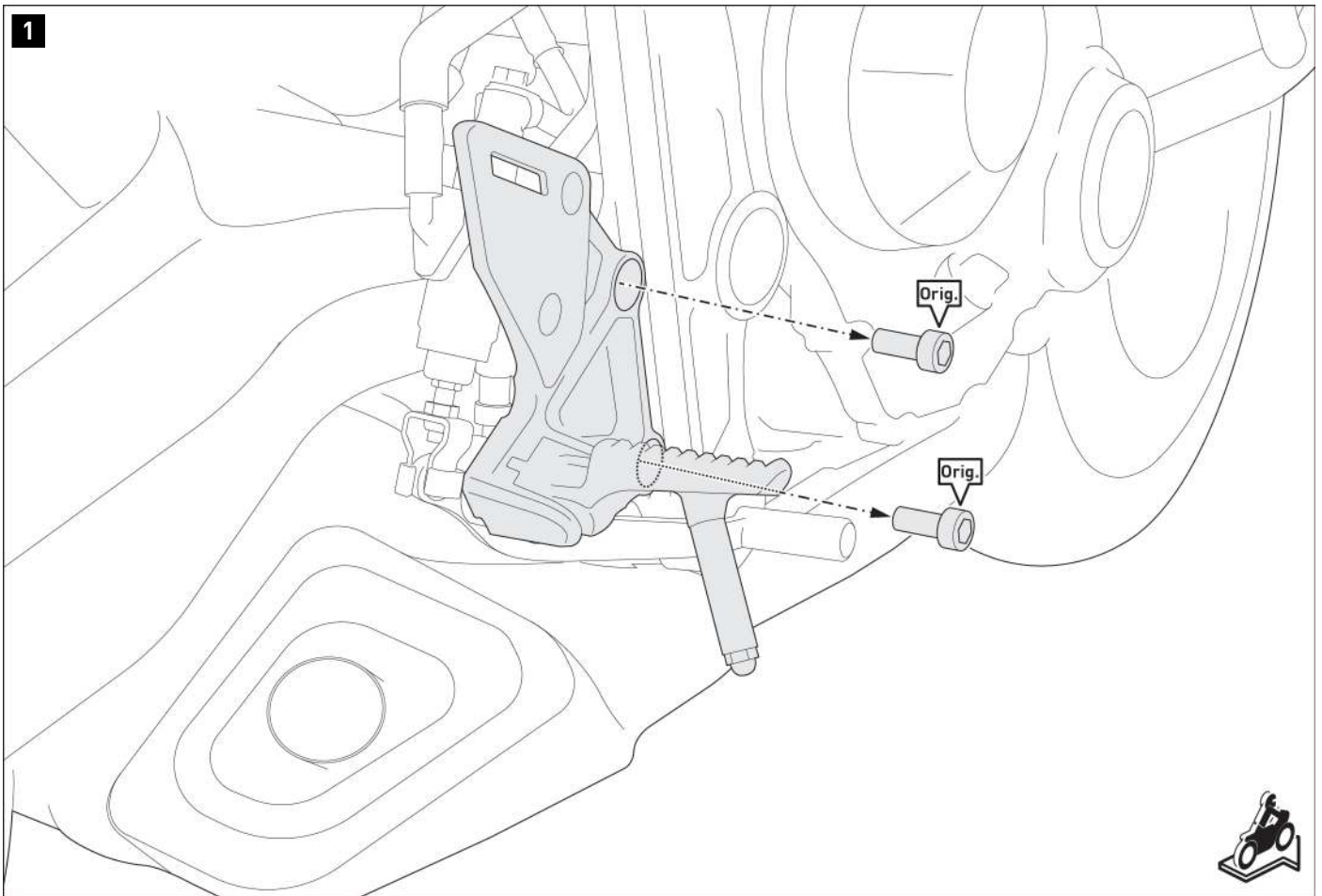

▲ GEFAHR: Bei einem Fußbremshebel handelt es sich um ein sicherheitsrelevantes Anbauteil!
Zu Ihrer Sicherheit empfiehlt SW-MOTECH, die Montage und/oder Wartung **UNBEDINGT** von einer qualifizierten und zertifizierten Fachwerkstatt durchführen zu lassen!

▲ WARNUNG: Tragen Sie immer Augen- und Handschutz!
▲ WARNUNG: Verwenden Sie immer geeignetes Werkzeug!

▲ HINWEIS: Notieren Sie sich vor Demontage des original Bremshebels die Reihenfolge und Ausrichtung der original Teile.

Entfernen Sie die gezeigten Schrauben von der rechten Fußrastenaufnahme.

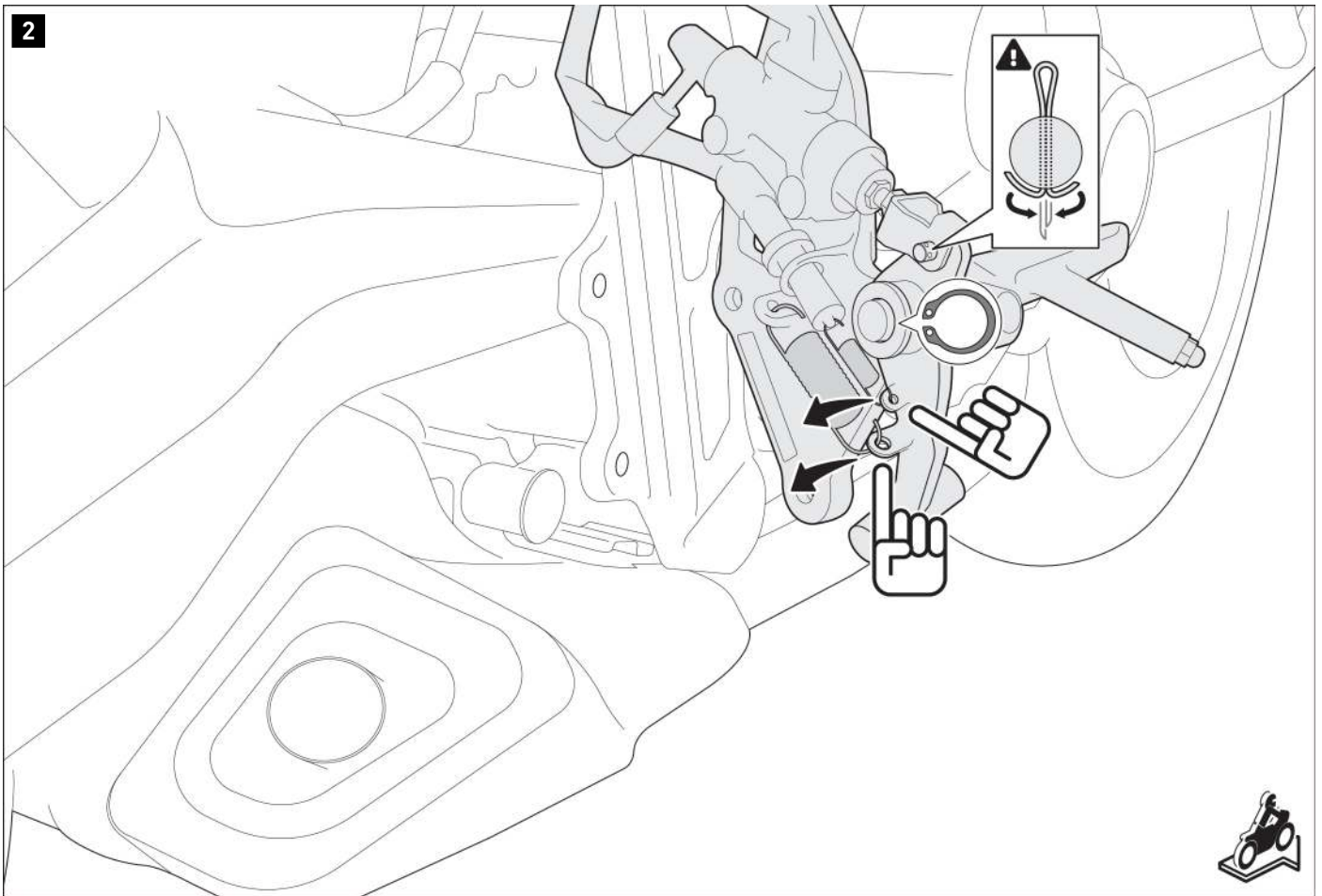

Lösen Sie den Sicherungssplint vom Druckstab des Hauptbremszylinders.
Hängen Sie die gezeigten Federn aus.
Entfernen Sie den Sicherungsring.

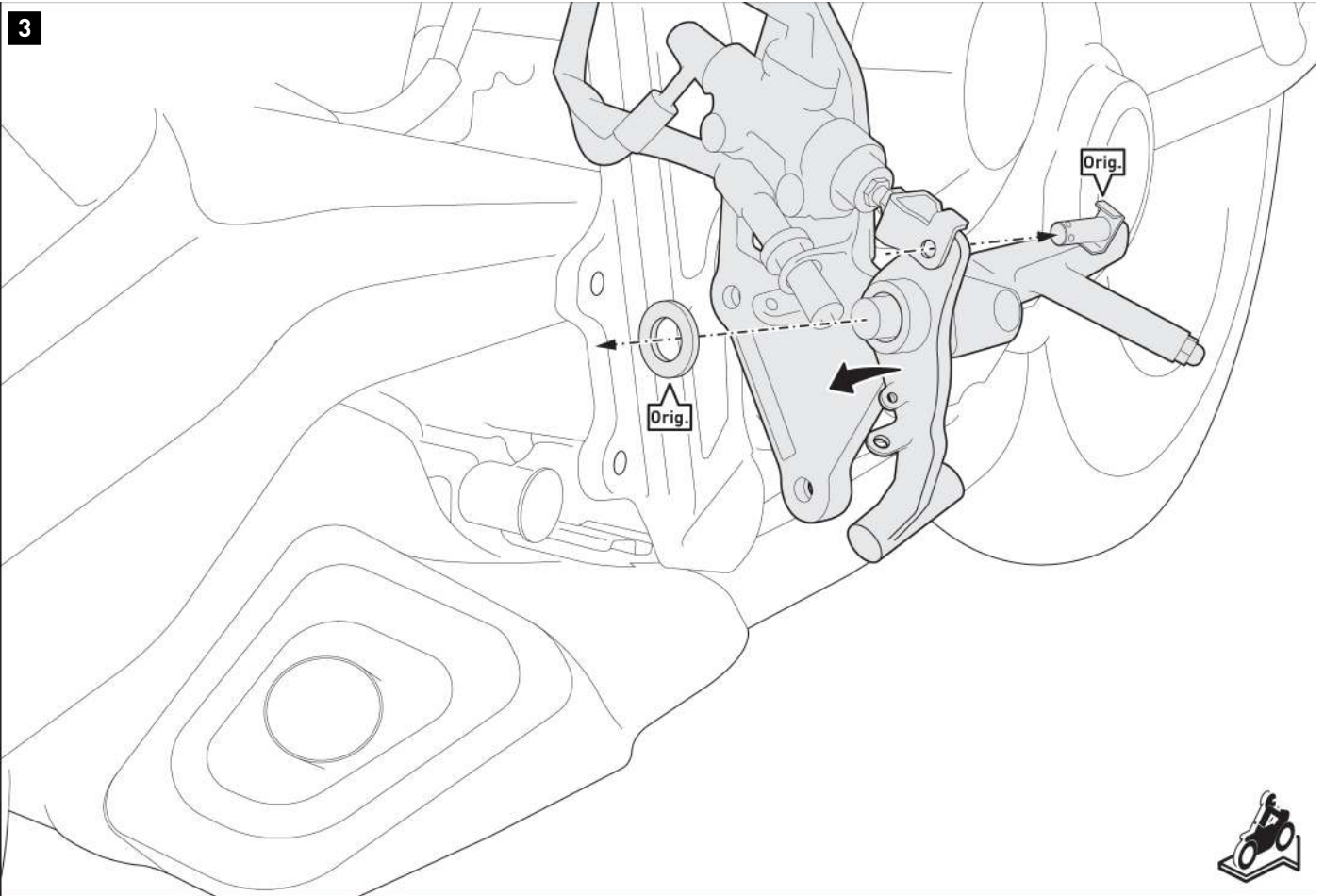

Entfernen Sie den original Bremshebel von der Fußrastenaufnahme.

4

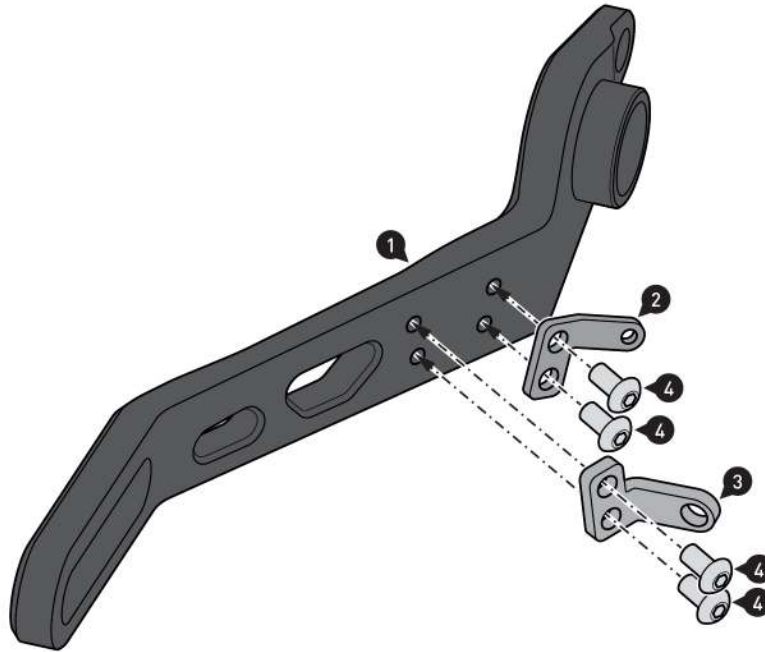

Verschrauben Sie die gezeigten Teile miteinander.

▲ WARNUNG: Verwenden Sie flüssige Schraubensicherung!

Ziehen Sie die Schrauben (4) wie in der Anbauanleitung vorgegeben an.



M 2,8 Nm

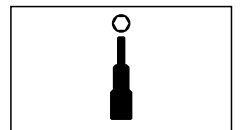
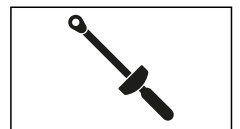

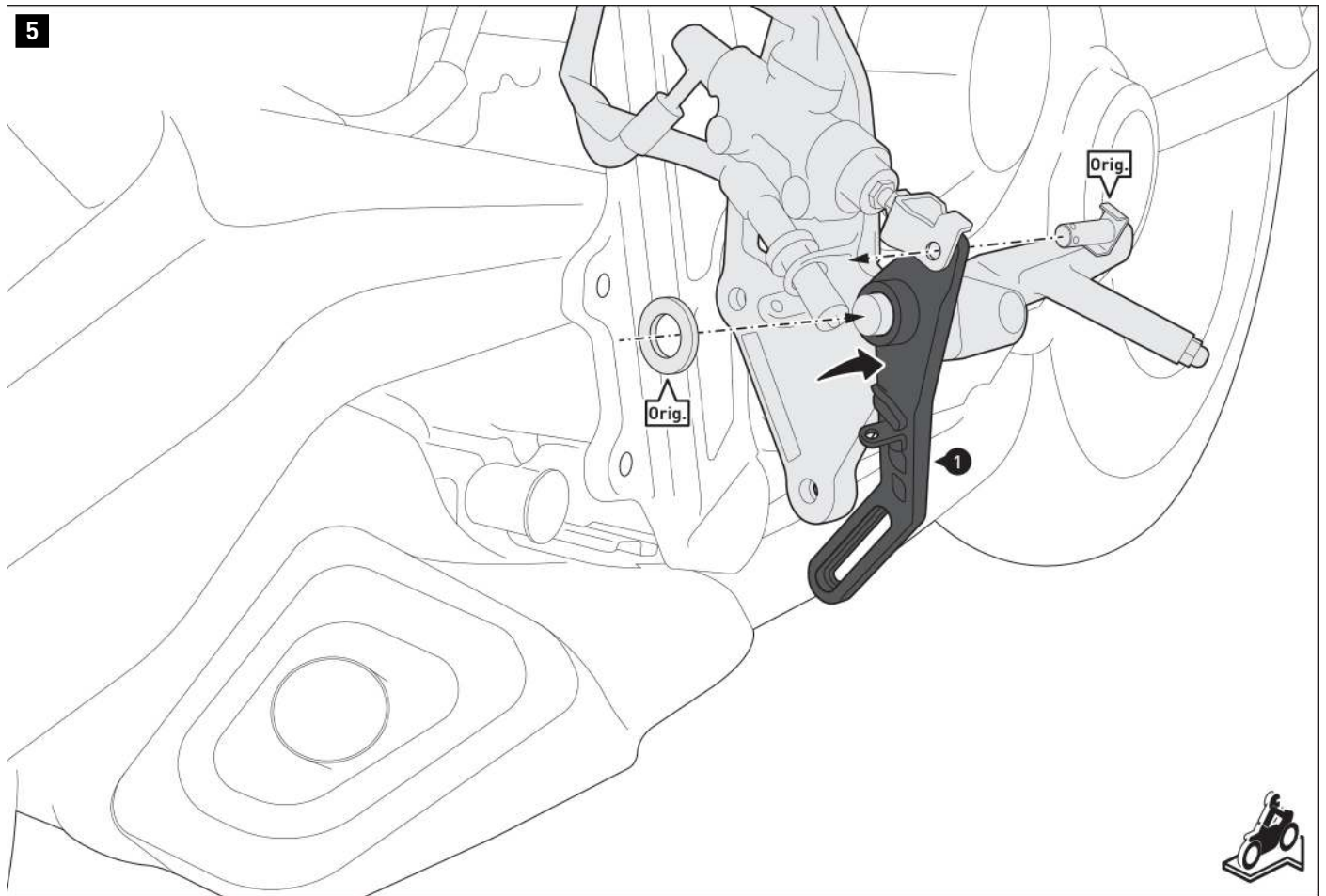

Montieren Sie den Fußbremshebel (1) mit den original Teilen (Orig.) an der Fußrastenaufnahme.

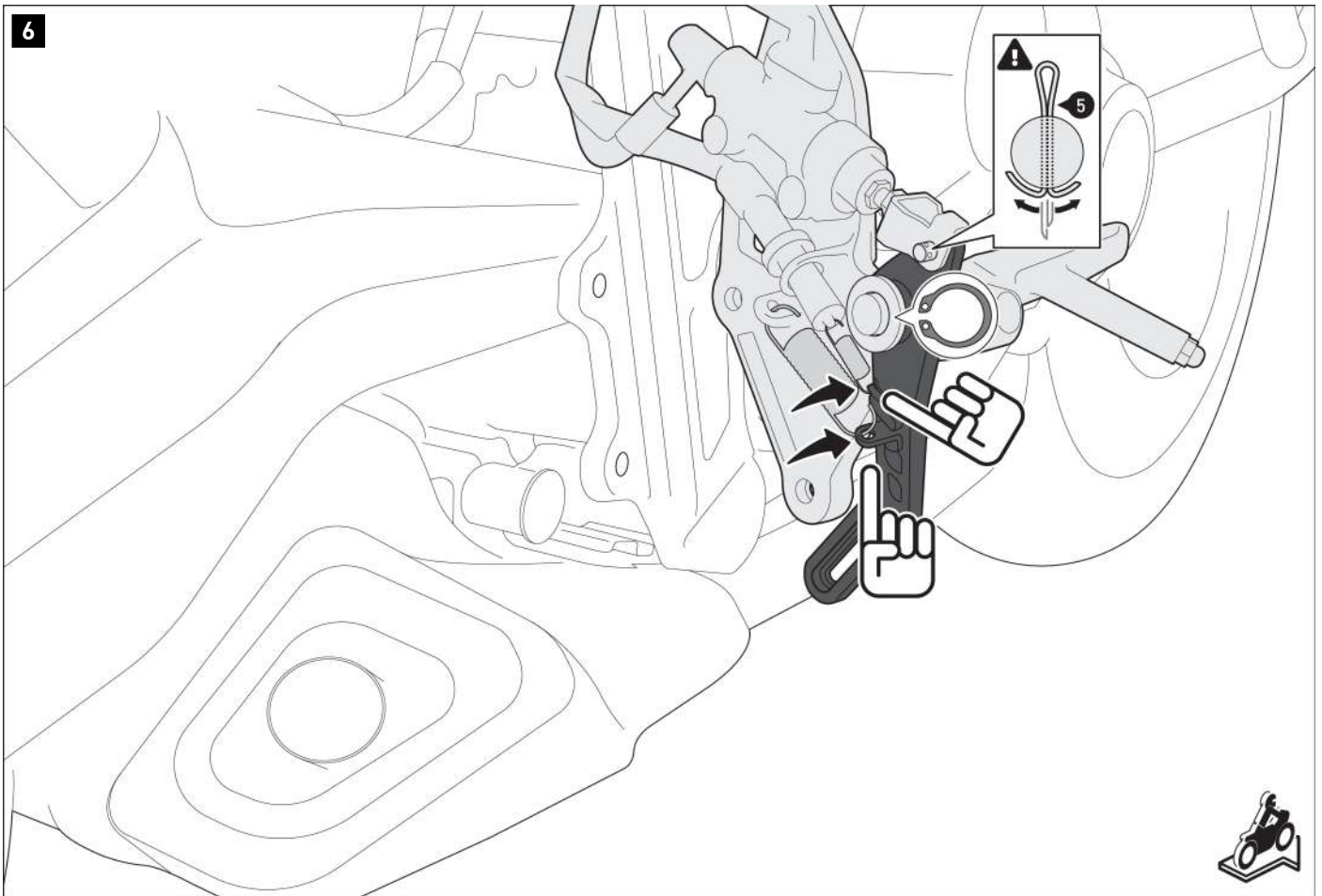

Hängen Sie die Federn an der gezeigten Position ein.
Montieren Sie den original Druckstab (Orig.) mit dem **neuen** Sicherungssplint (5).
Montieren Sie den original Sicherungsring.



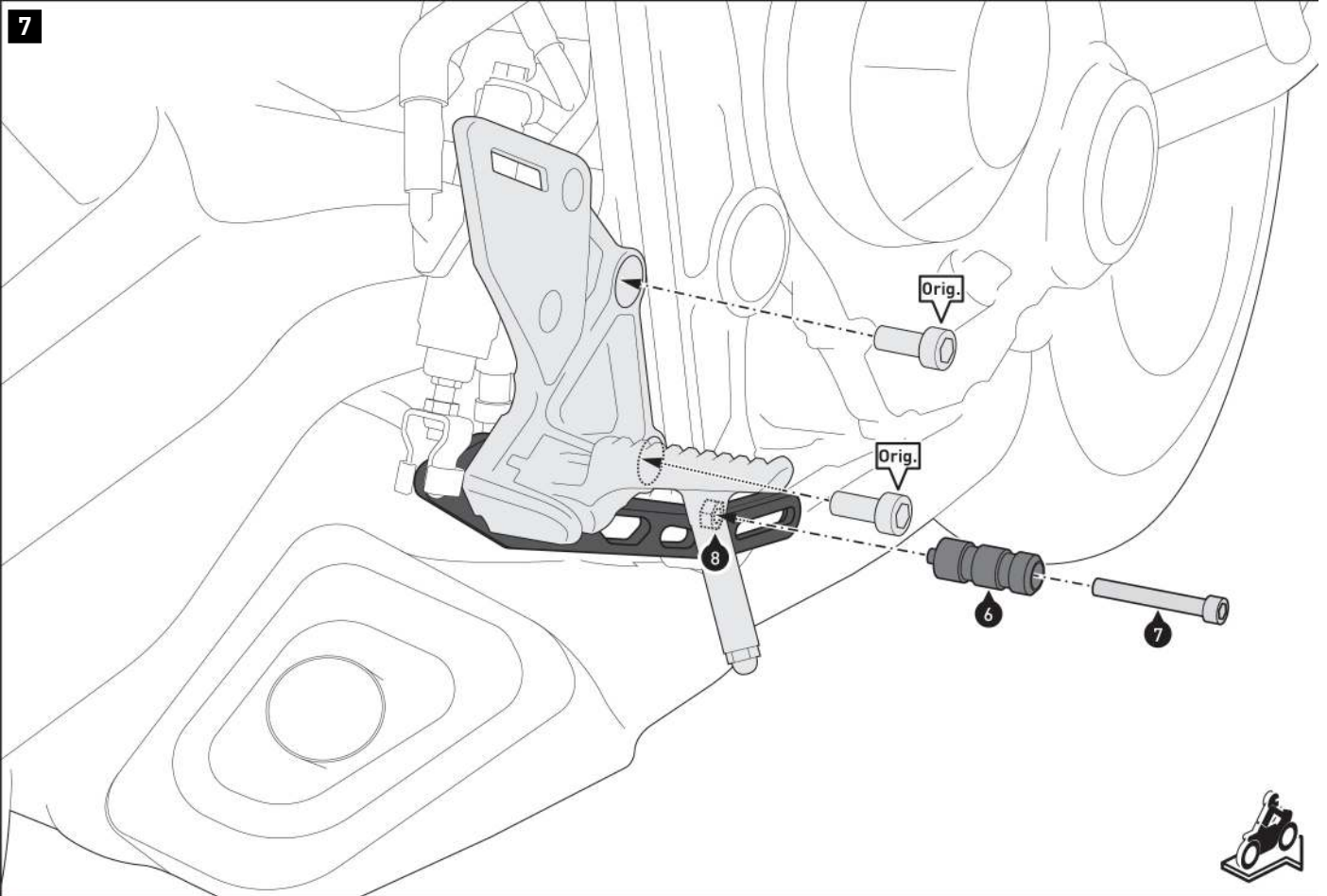

Verschrauben Sie den Auftritt (6) am Fußbremshebel.
Ziehen Sie die Schraube (7) noch nicht an.

Verschrauben Sie die Fußrastenaufnahme mit den original Schrauben (Orig.)
am Fahrzeug.

⚠️ WARNUNG: Verwenden Sie flüssige Schraubensicherung! (nur (Orig.))
Ziehen Sie die original Schrauben (Orig.) nach Herstellerangaben an.

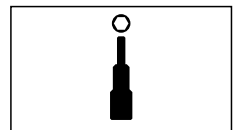
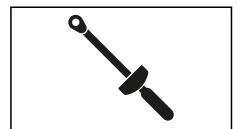

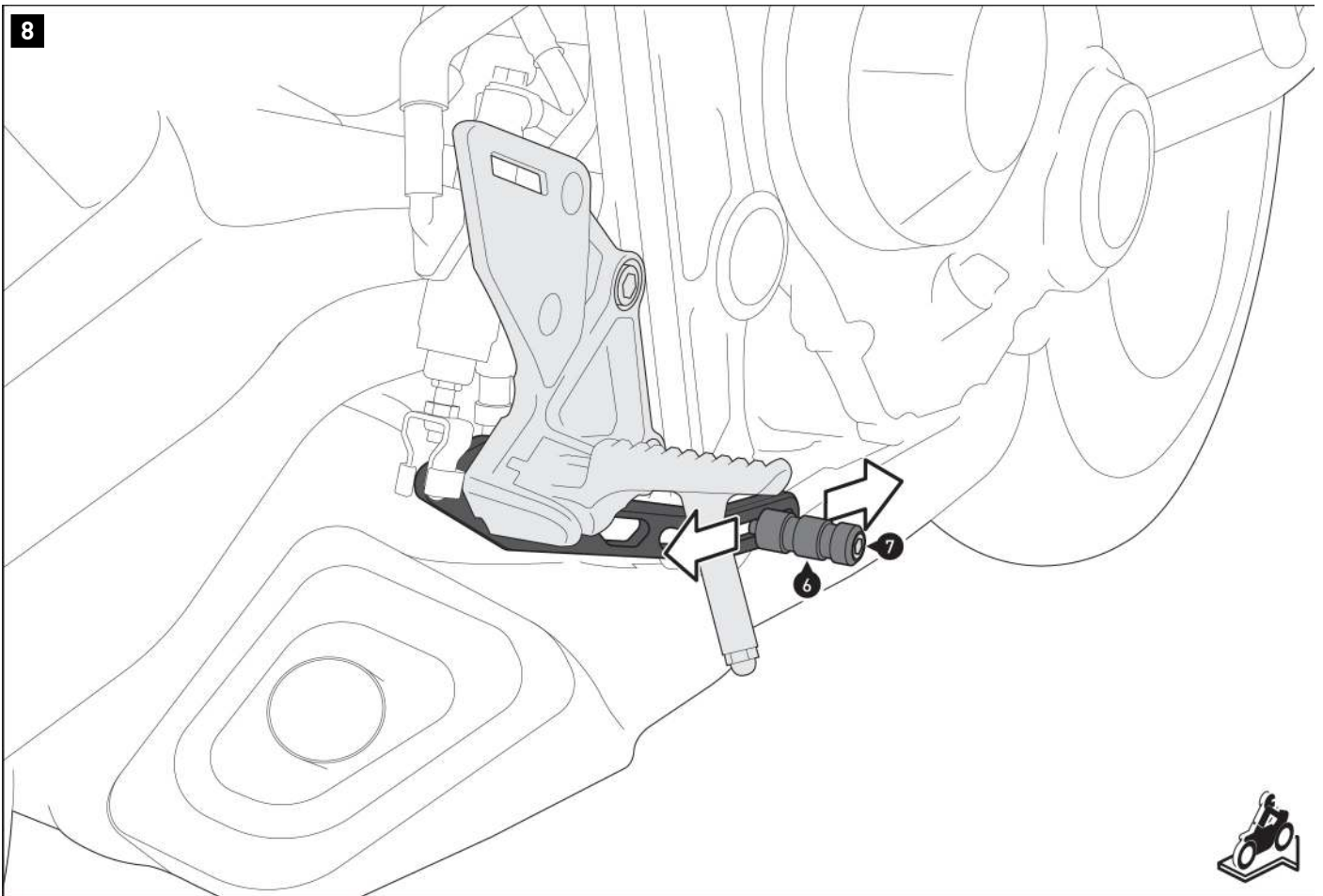

Stellen Sie den Auftritt (6) entsprechend Ihrer Fahrgewohnheiten ein.
Ziehen Sie anschließend die Schraube (7) wie in der Anbauanleitung
vorgegeben an.

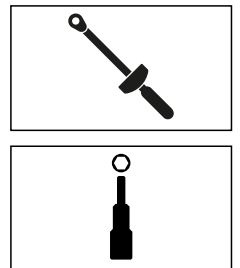

PRODUKTSPEZIFISCHE HINWEISE

▲ GEFAHR: Lassen Sie abschließend eine umfangreiche Funktionskontrolle der Bremsanlage Ihres Fahrzeugs von einer qualifizierten und zertifizierten Fachwerkstatt durchführen!

▲ WARNUNG: Die Kurven- und Bodenfreiheit kann bei extremer Schräglage durch dieses Produkt eingeschränkt werden!

▲ HINWEIS: Beachten Sie die landesspezifischen Vorschriften für Zulassung/Betrieb Ihres Fahrzeugs bzw. anwendbare TÜV-Vorschriften. Lassen Sie eintragungspflichtige Teile nach Montage durch Ihre Prüfstelle in die Fahrzeugpapiere eintragen.

Sofern für dieses Produkt eine Allgemeine Betriebserlaubnis (ABE) vorliegt: Die mit dem Produkt ausgelieferte ABE muss immer mitgeführt werden! Diese ABE gilt nur für die gelisteten Modelle und unter Beachtung aller Auflagen! Für eine Verwendung am hier nicht aufgeführten Fahrzeug muss die Eintragung in die Fahrzeugpapiere vorgenommen werden!

Die Fahrzeugzuweisungen im ABE-Dokument werden jährlich erweitert. Dadurch kann die ABE für ein neues Produkt unter Umständen erst einige Monate nach Markteinführung erfolgen. Wird Ihr Modell nicht aufgelistet oder sollte Ihnen das ABE-Dokument nicht mehr vorliegen, besuchen Sie bitte die Download-Sektion unseres Webshops. Dort steht Ihnen das ABE-Dokument in seiner jeweils aktuellen Version zur Verfügung.

Item number: **FBL.01.529.10000**

Revision: **00** · Date: **09 - 2023**

Brake pedal

 ~ 1 h.

EASY  DIFFICULT

ENGLISH Thank you for choosing this premium product from SW-MOTECH. Visit our online shop for more information (e.g. model assignments). Required documents (e.g. national type approval) are available there for you to download.

Please read and understand all the instructions, safety information and warnings in these mounting instructions before mounting and using the product in order to avoid injury and damage. Keep these mounting instructions for reference.

This product was developed for vehicles in factory condition. Compatibility with original accessories or accessories from other manufacturers cannot be guaranteed.

These mounting instructions have been prepared to the best of our current knowledge. No legal claims relating to accuracy can be made. Errors and omissions excepted. We reserve the right to make technical and design changes. The copyright is held by SW-MOTECH.

SAFETY WARNING SYMBOL

 This warning symbol is used in these mounting instructions to warn of deadly dangers, injuries or other hazards. The words **DANGER**, **WARNING** or **CAUTION** are used as part of this warning symbol to convey important safety messages and information relating to the installation and use of this product. These words, together with the safety warning symbol, mean:

 **DANGER:** Indicates a hazardous situation which, if not avoided, will result in death or serious injury!

 **WARNING:** Indicates a hazardous situation which, if not avoided, may result in death or serious injury!

 **CAUTION:** Indicates a hazardous situation which, if not avoided, may result in minor or moderate injury!

 **NOTE:** Important information, but not relating to a risk of death or injury (property damage only)!

GENERAL INFORMATION

 **WARNING:** Assembly and/or maintenance of this product requires advanced technical skill, appropriate tools, and a good understanding of tool usage and torque specifications. For your own safety, SW-MOTECH recommends having the assembly and/or maintenance carried out by a qualified and certified motorcycle workshop.

 **WARNING:** If you do choose to assemble this product yourself, carefully and fully read the mounting instructions before assembly and use, and follow all instructions to avoid serious injury or death. Also observe all relevant information in the vehicle manual when mounting or using the product. IF YOU DO NOT UNDERSTAND ANY PART OF THESE MOUNTING INSTRUCTIONS OR NEED AN EXPLANATION AS TO A SPECIFIC INSTRUCTION, DO NOT ATTEMPT TO INSTALL THIS PRODUCT WITHOUT CONSULTING SW-MOTECH FOR ASSISTANCE!

PREPARATION: Read the mounting instructions carefully and make sure that all parts on the parts list are available.

 **CAUTION:** Ensure that your vehicle is standing securely. Switch off the engine and remove the ignition key. Allow the engine/exhaust to cool down if necessary. Disconnect the battery when working on the electrical system. Only use proper tools and always wear safety goggles and gloves during assembly and maintenance. Have a second person help you with assembly and maintenance.

ASSEMBLY: All parts and connections removed from the vehicle must be reinstalled according to the vehicle manufacturer's specifications or replaced with parts and hardware supplied by SW-MOTECH.

 **WARNING:** Secure all threads with a medium-strength liquid threadlocker, unless otherwise specified.

 **DANGER:** Tightening torques not defined by SW-MOTECH must be obtained from the vehicle manufacturer or a certified motorbike workshop.

FUNCTIONAL CHECK: After mounting the product, ensure that no moving parts are obstructed and that the function of the vehicle is not impeded. Cables and hoses must not rub against each other and/or be hindered in any way.

 **WARNING:** Carry out a comprehensive functionality check before you start to drive. Check the tightening torque of all connections and the tight fit of the product after the first 50 km and then at regular intervals. Mounted accessories can change the handling and stability of the vehicle.



SW-MOTECH GmbH & Co. KG
Ernteweg 7-10
35282 Rauschenberg
Germany



info@sw-motech.com
www.sw-motech.com



Take note of the symbols and what they mean in the ASSEMBLY section. If the term OEM appears in the ASSEMBLY section, the vehicle manufacturer's specifications must be observed and applied.



If you have any questions, please don't hesitate to contact our Customer Service team or our distributors. You can find our telephone number and a list of our distributors in our online shop:

www.sw-motech.com



Use thread locker: Indicates that a thread must be coated with liquid thread locker. H (HIGH): high strength; M (MEDIUM): medium strength; L (LOW): low strength.



Tighten/note the tightening torque information: Indicates the tightening torque of a part specified by SW-MOTECH or the vehicle manufacturer (OEM).



Do not use thread lock: Indicates that no liquid thread lock should be used at this point.

PARTS LIST - READ AND KEEP MOUNTING INSTRUCTIONS!

4

1



FBL.01.529.900.01.02

 1/1

2



FBL.01.529.003.03

 1/1

3



FBL.01.529.004.03

 1/1

4



M4 x 8; ISO 7380
SC.ST.04.008.02.73800.109

 4/4

6

5



SP.ST.020.016.01.94

 1/1

7

6



FBL.00.127.003.36

 1/1

7



M6 x 50; DIN 912
SC.ST.06.050.01.912.088

 1/1

8



M6; DIN 985
MU.ST.06.01.985.08

 1/1

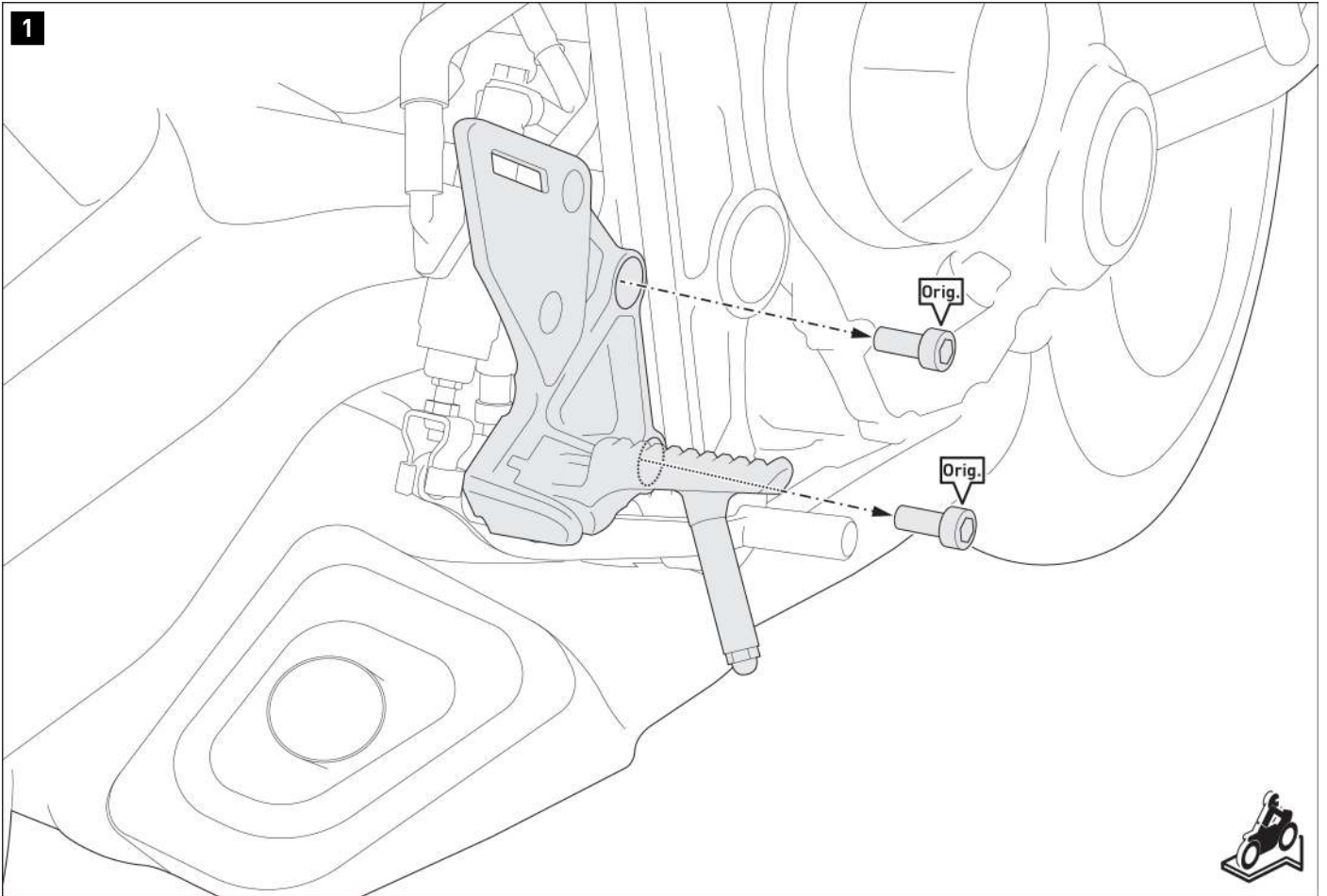

⚠ DANGER: A brake pedal is a safety-relevant attachment!
For your safety, SW-MOTECH recommends that installation and/or maintenance be carried out by a qualified and certified specialist workshop!

⚠ WARNING: Always wear eye and hand protection!
⚠ WARNING: Always use suitable tools!

⚠ NOTE: Before disassembling the original brake pedal, note the order and orientation of the original parts.

Remove the screws shown from the right footpeg mount.

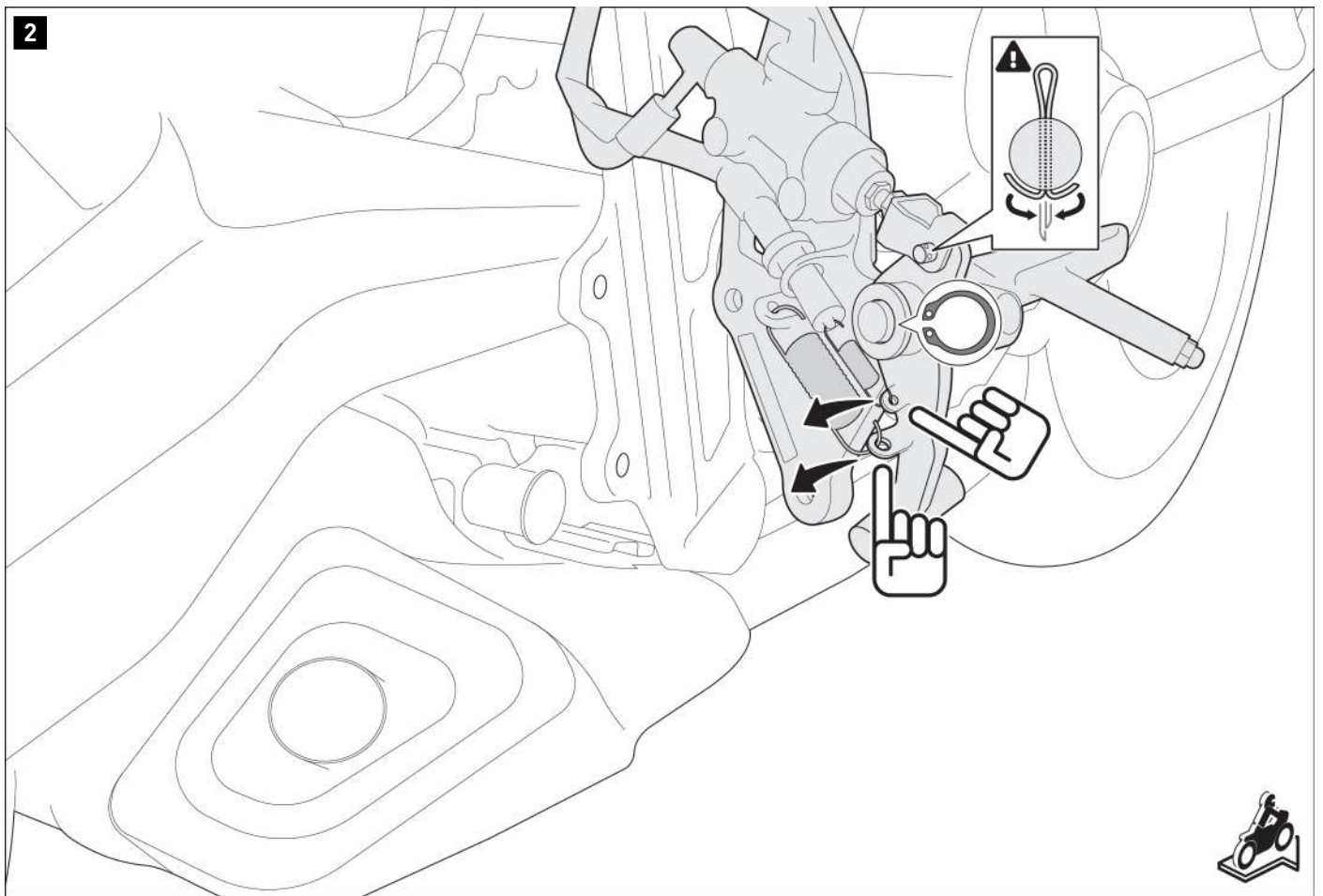

Loosen the cotter pin from the master cylinder push rod.
Unhook the indicated springs.
Remove the snap ring.

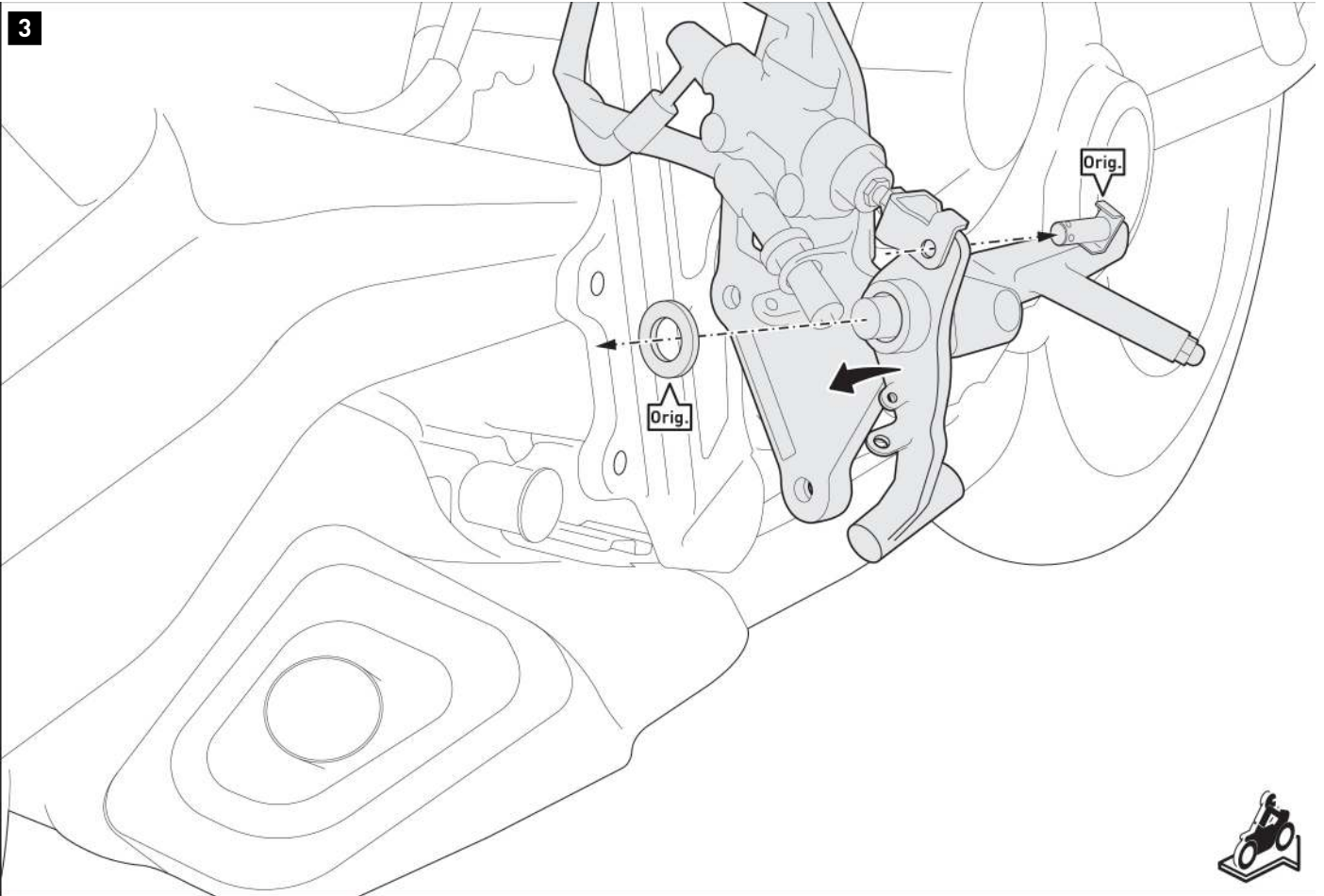

Remove the original brake pedal from the footrest mount.

4

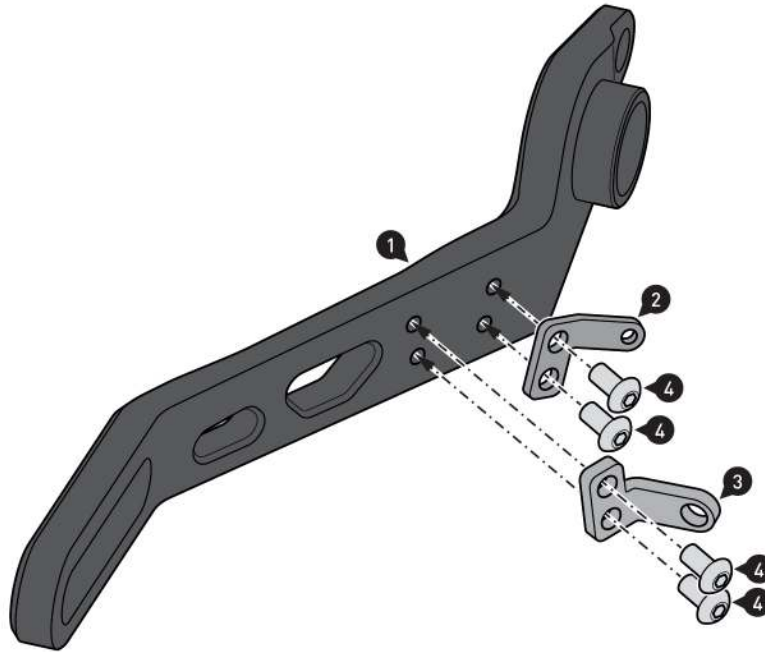

Screw the parts shown together.

▲ WARNING: use liquid thread locker!

Tighten the screws (4) as specified in the mounting instructions.

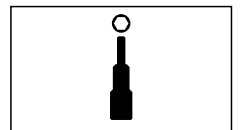
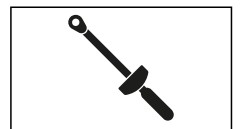

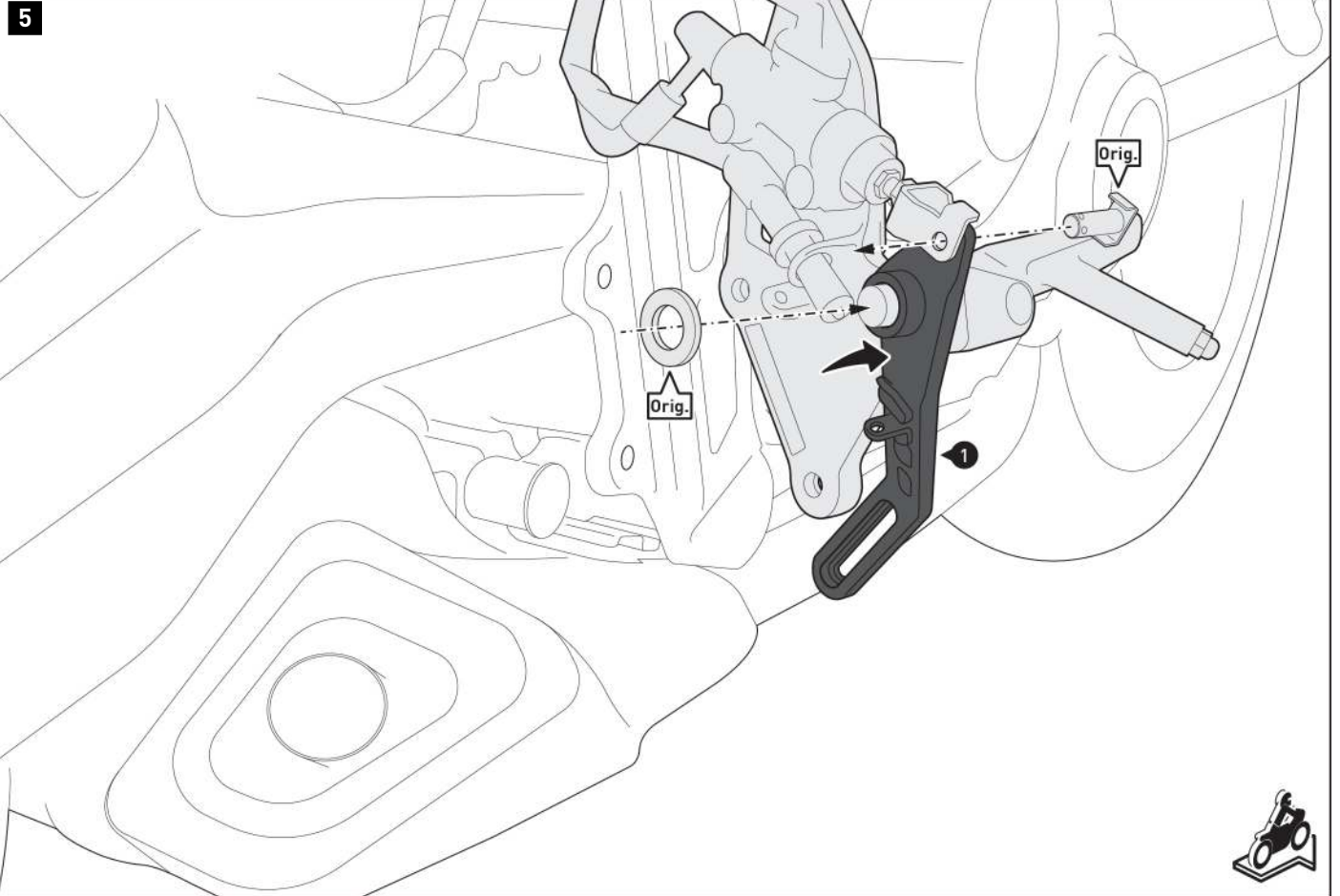

Attach the brake pedal (1) to the footrest mount using the original parts (Orig.).

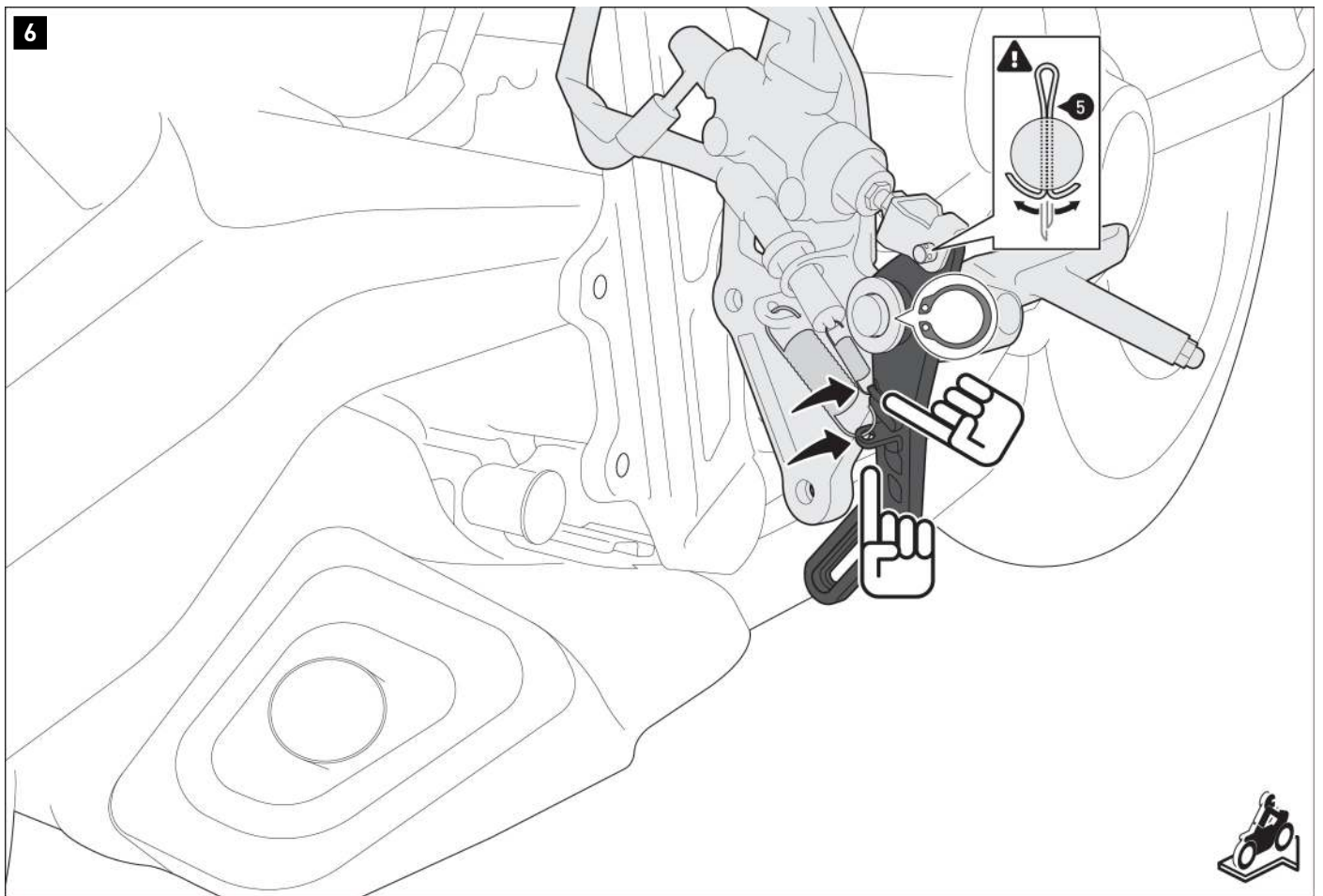

Hang the springs in the indicated position.
Mount the original pressure rod (Orig.) using the **new** cotter pin (5).
Attach the original snap ring.



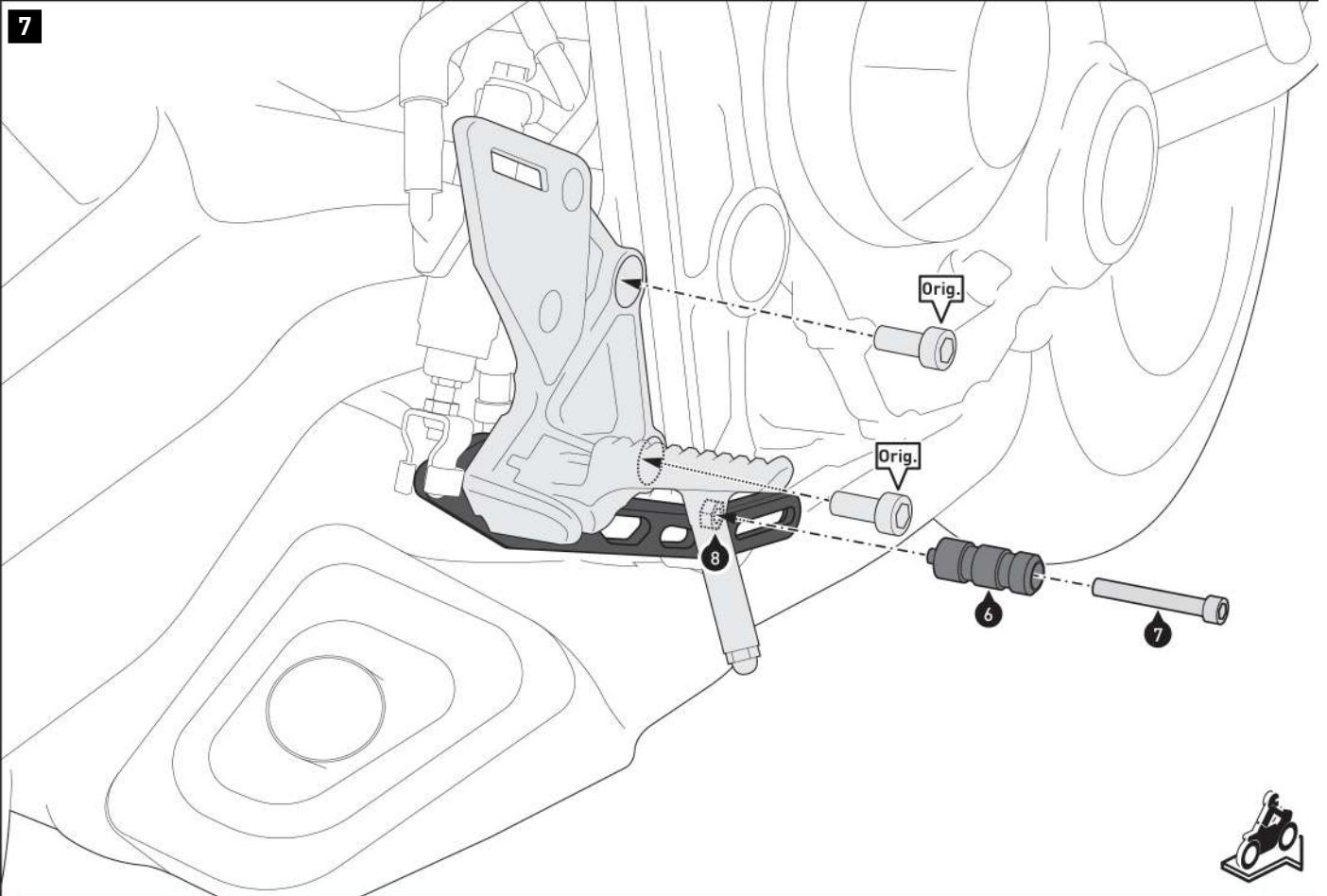

Screw the pedal (6) onto the brake pedal.
Do not tighten the screw (7) yet.

Screw the footrest mount onto the vehicle using the original screws (Orig.).
▲ WARNING: Use liquid thread locker! (only for (Orig.))
Tighten the original (Orig.) screws according to the manufacturer's instructions.

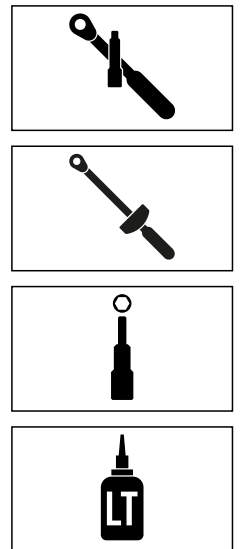
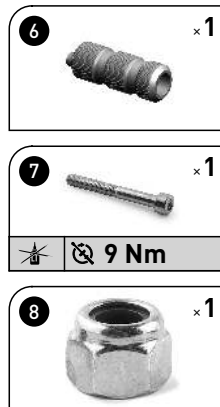

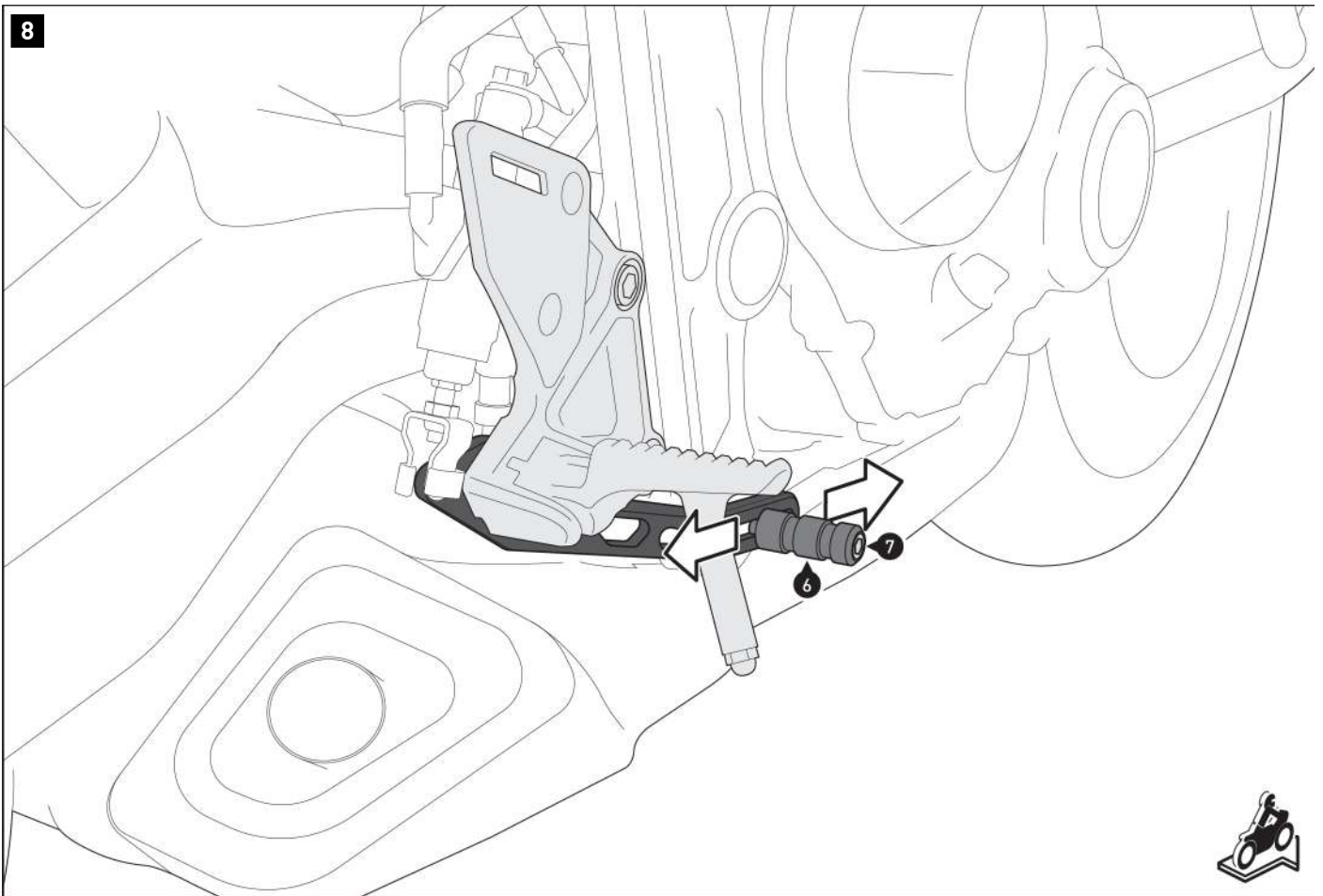

Adjust the pedal [6] according to your personal preference.
Then tighten the screw [7] as specified in the mounting instructions.

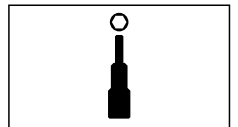

PRODUCT-SPECIFIC NOTES

⚠ DANGER: Finally, have a comprehensive functional check of your vehicle's brake system carried out by a qualified and certified specialist workshop!

⚠ WARNING: The cornering and ground clearance may be restricted by this product in the case of extreme inclination!

⚠ NOTE: Observe the country-specific regulations for registering/operating your vehicle or the applicable TÜV regulations. Have parts subject to registration entered in the vehicle documents by your inspection authority after installation.

If a national type approval is available for this product:

You must always carry the national type approval supplied with the product with you! This national type approval only applies to the models listed and must comply with all requirements! For use with a vehicle not listed here, the entry must be made in the vehicle documents!

The vehicle assignments in the national type approval document are expanded annually. As a result, the national type approval for a new product may only take place a few months after the market launch. If your model is not listed or if you no longer have the national type approval document, please visit the Download section of our web shop. The current version of the national type approval document will be available there.

Número de artículo: **FBL.01.529.10000**Revisión: **00** · Fecha: **09 - 2023****Pedal de freno** ~ 1 h.**FÁCIL**     **COMPLICADO**

ESPAÑOL · Gracias por elegir este producto de primera calidad de SW-MOTECH. Visite nuestra tienda online para obtener más información (p. ej., sobre el uso de los modelos). Desde esa página podrá descargar los documentos que necesite (por ejemplo, la homologación nacional de tipo).

Para evitar lesiones y daños, asegúrese de leer y comprender todas las instrucciones, advertencias de seguridad y precauciones de este manual antes de montar y utilizar el producto. Guarde estas instrucciones de montaje como referencia.

Este producto ha sido desarrollado para vehículos en condiciones de fábrica. No se garantiza la compatibilidad con los accesorios originales o de otros fabricantes.

Estas instrucciones de montaje se han redactado de acuerdo con nuestros conocimientos actuales. No hay reclamaciones legales de corrección. Salvo errores y omisiones. Nos reservamos el derecho a realizar cambios técnicos y de diseño. Los derechos de autor pertenecen a SW-MOTECH.

SÍMBOLO DE ADVERTENCIA DE SEGURIDAD

 Este símbolo de advertencia se utiliza en estas instrucciones de montaje para advertir de peligros mortales, lesiones u otros riesgos. Las palabras **PELIGRO**, **ATENCIÓN** o **PRECAUCIÓN** se utilizan con este símbolo de advertencia para transmitir importantes avisos de seguridad e información relacionada con el montaje y uso de este producto. Estas palabras, junto con el símbolo de advertencia de seguridad, significan:

 **PELIGRO:** Indica una situación de peligro que, si no se evita, provoca lesiones graves o incluso la muerte.

 **ATENCIÓN:** Indica una situación de peligro que, si no se evita, puede provocar lesiones graves o incluso la muerte.

 **PRECAUCIÓN:** Indica una situación de peligro que, si no se evita, puede provocar lesiones leves o de gravedad media.

 **NOTA:** Información importante, pero que no está relacionada con un riesgo de lesiones o muerte (solo daños materiales).

INDICACIONES GENERALES

 **ATENCIÓN:** El montaje y/o mantenimiento de este producto requiere conocimientos técnicos avanzados, las herramientas apropiadas, un buen manejo de dichas herramientas y conocer las especificaciones de los pares de apriete. Por su propia seguridad, SW-MOTECH recomienda que el montaje y/o el mantenimiento los realice un taller de motocicletas cualificado y certificado.

 **ATENCIÓN:** Si elige ensamblar este producto usted mismo, antes de montarlo y usarlo, lea las instrucciones de montaje detenidamente y en su totalidad, y siga todas las indicaciones para evitar lesiones graves o mortales. Cuando monte y utilice el producto, tenga también en cuenta toda la información relevante que figure en el manual del vehículo. **SI NO ENTIENDE ALGUNA PARTE DE ESTAS INSTRUCCIONES DE MONTAJE O NECESITA ALGUNA ACLARACIÓN, NO INTENTE INSTALAR ESTE PRODUCTO SIN CONSULTAR A SW-MOTECH PARA OBTENER AYUDA.**

PREPARACIÓN: Lea atentamente las instrucciones de montaje y asegúrese de que todas las piezas de la lista de piezas están presentes.

 **PRECAUCIÓN:** Asegúrese de que su vehículo esté estacionado de manera segura. Apague el motor y retire la llave de encendido. Deje que el motor o el escape se enfrien si es necesario. Desconecte la batería cuando trabaje en el sistema eléctrico. Utilice únicamente las herramientas adecuadas y use siempre gafas de seguridad y guantes al realizar el montaje y las tareas de mantenimiento. Pida a otra persona que le ayude con el montaje y el mantenimiento.

MONTAJE: Todas las piezas y conexiones retiradas del vehículo deben ser reinstaladas de acuerdo con las especificaciones del fabricante del vehículo o sustituidas por piezas y herrajes suministrados por SW-MOTECH.

 **ATENCIÓN:** Asegure todas las roscas con fijador de roscas líquido de resistencia media, a menos que se especifique lo contrario.

 **PELIGRO:** Los pares de apriete no definidos por SW-MOTECH deben obtenerse del fabricante del vehículo o de un taller de motocicletas certificado.

COMPROBACIÓN FUNCIONAL: Después del montaje, asegúrese de que no haya piezas móviles bloqueadas y de que no se altere el funcionamiento del vehículo. Los cables y tubos no deben rozarse ni quedar pinzados.

 **ATENCIÓN:** Realice una comprobación exhaustiva del funcionamiento antes de iniciar la marcha. Tras los primeros 50 km y, después, con regularidad, compruebe el par de apriete de todas las conexiones y que el producto está firmemente sujeto. Los accesorios instalados pueden cambiar el comportamiento de conducción y la estabilidad del vehículo.



SW-MOTECH GmbH & Co. KG
Ernteweg 7-10
35282 Rauschenberg
Alemania



info@sw-motech.com
www.sw-motech.com



Preste atención a los símbolos que figuran en la sección de MONTAJE y su significado. Cuando, en la sección de MONTAJE, aparecen las siglas OEM, se deberán seguir y aplicar las especificaciones del fabricante del vehículo.



Si tiene alguna pregunta, nuestro servicio de atención al cliente y nuestros distribuidores estarán encantados de prestarle ayuda. Encontrará nuestro número de teléfono y una lista de nuestros distribuidores en nuestra tienda online:

www.sw-motech.com



Usar fijador de roscas: Indica que una rosca debe recubrirse con fijador de roscas líquido. H (HIGH): resistencia alta; M (MEDIUM): resistencia media; L (LOW): resistencia baja.



Respete la información del par de apriete: Indica el par de apriete de una pieza especificada por SW-MOTECH o el fabricante del vehículo (OEM).



No usar fijador de roscas: Indica que no es necesario usar fijador de roscas líquido en este punto.

LISTA DE PIEZAS - LEE Y CONSERVA LAS INSTRUCCIONES DE MONTAJE!

4

1



FBL.01.529.900.01.02

 1/1

2



FBL.01.529.003.03

 1/1

3



FBL.01.529.004.03

 1/1

4



M4 x 8; ISO 7380
SC.ST.04.008.02.73800.109

 4/4

6

5



SP.ST.020.016.01.94

 1/1

7

6



FBL.00.127.003.36

 1/1

7



M6 x 50; DIN 912
SC.ST.06.050.01.912.088

 1/1

8



M6; DIN 985
MU.ST.06.01.985.08

 1/1

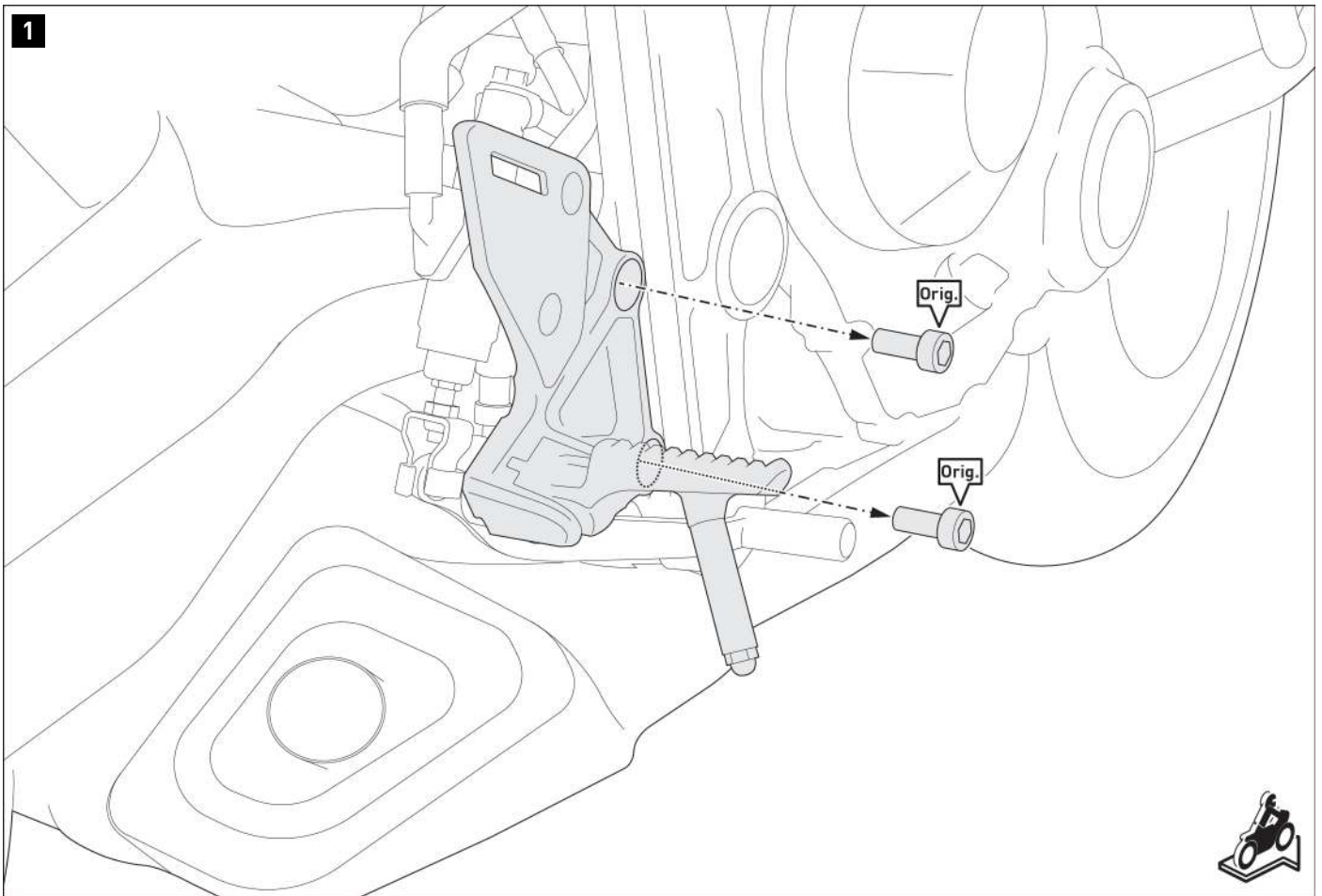

▲ PELIGRO: ¡Un pedal de freno es un componente importante para la seguridad!
¡Por su seguridad, SW-MOTECH recomienda que el montaje y/o el mantenimiento sean realizados SIEMPRE por un taller especializado, cualificado y certificado!

▲ ATENCIÓN: ¡Use siempre protección de ojos y manos!
▲ ATENCIÓN: ¡Utilice siempre las herramientas apropiadas!

▲ NOTA: Antes de desmontar el pedal de freno original, tenga en cuenta el orden y la posición de las piezas originales.

Quite los tornillos indicados del soporte del reposapiés derecho.

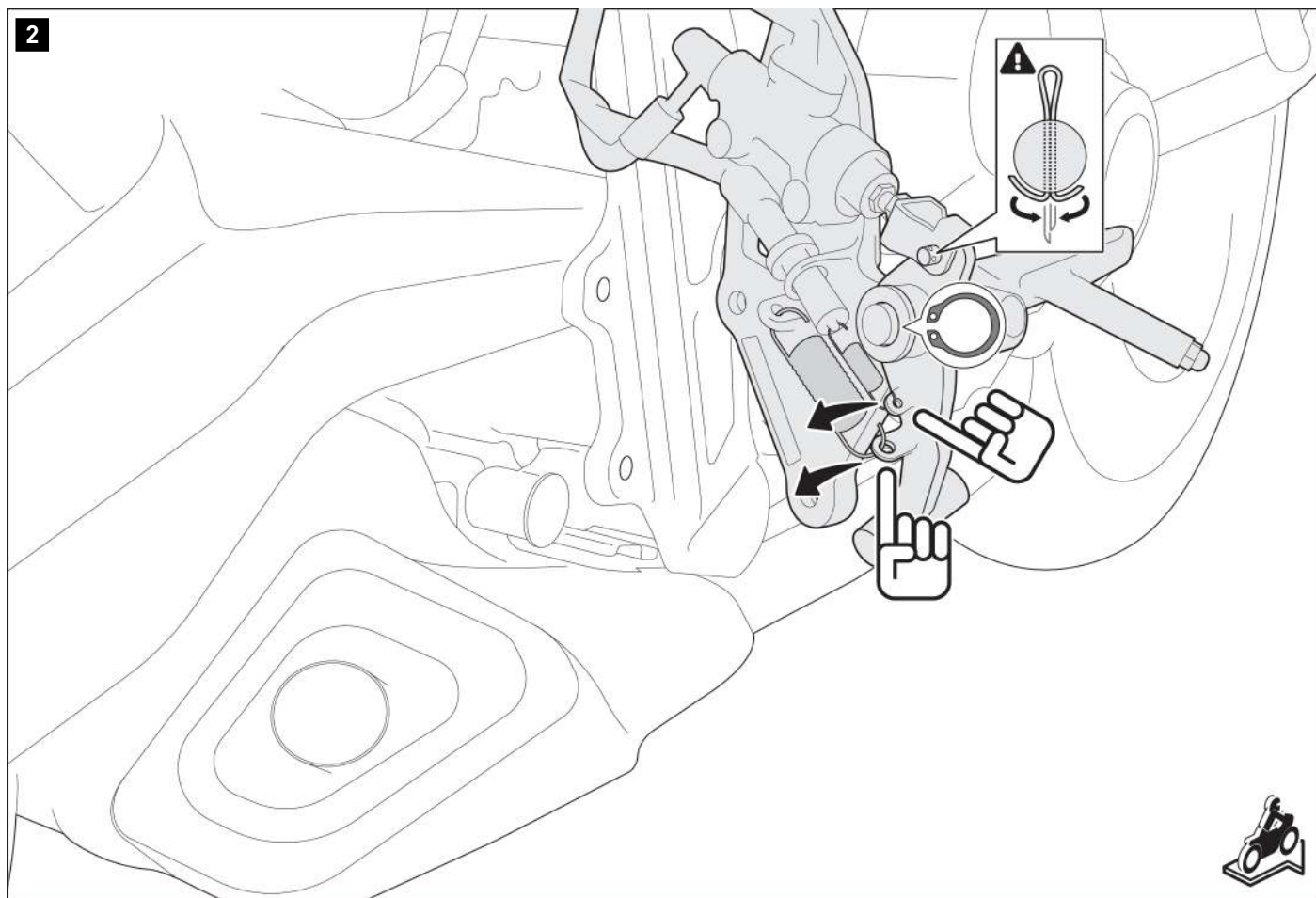

Afloje la chaveta de seguridad de la varilla de presión del cilindro maestro.
Desenganche los resortes señalados.
Retire el anillo de bloqueo.



Retire el pedal de freno original del soporte para reposapiés.

4

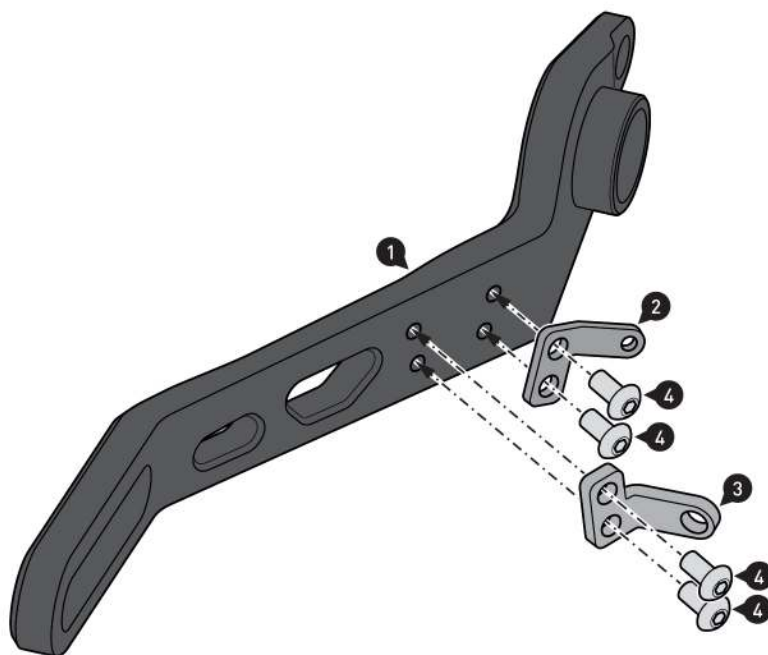

Atornille juntas las piezas indicadas.

▲ ATENCIÓN: ¡Utilice fijador de roscas líquido!

Apriete los tornillos (4) como se especifica en las instrucciones de montaje.

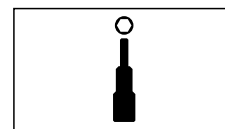
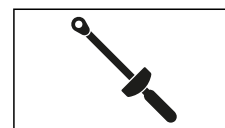
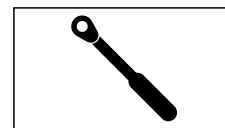

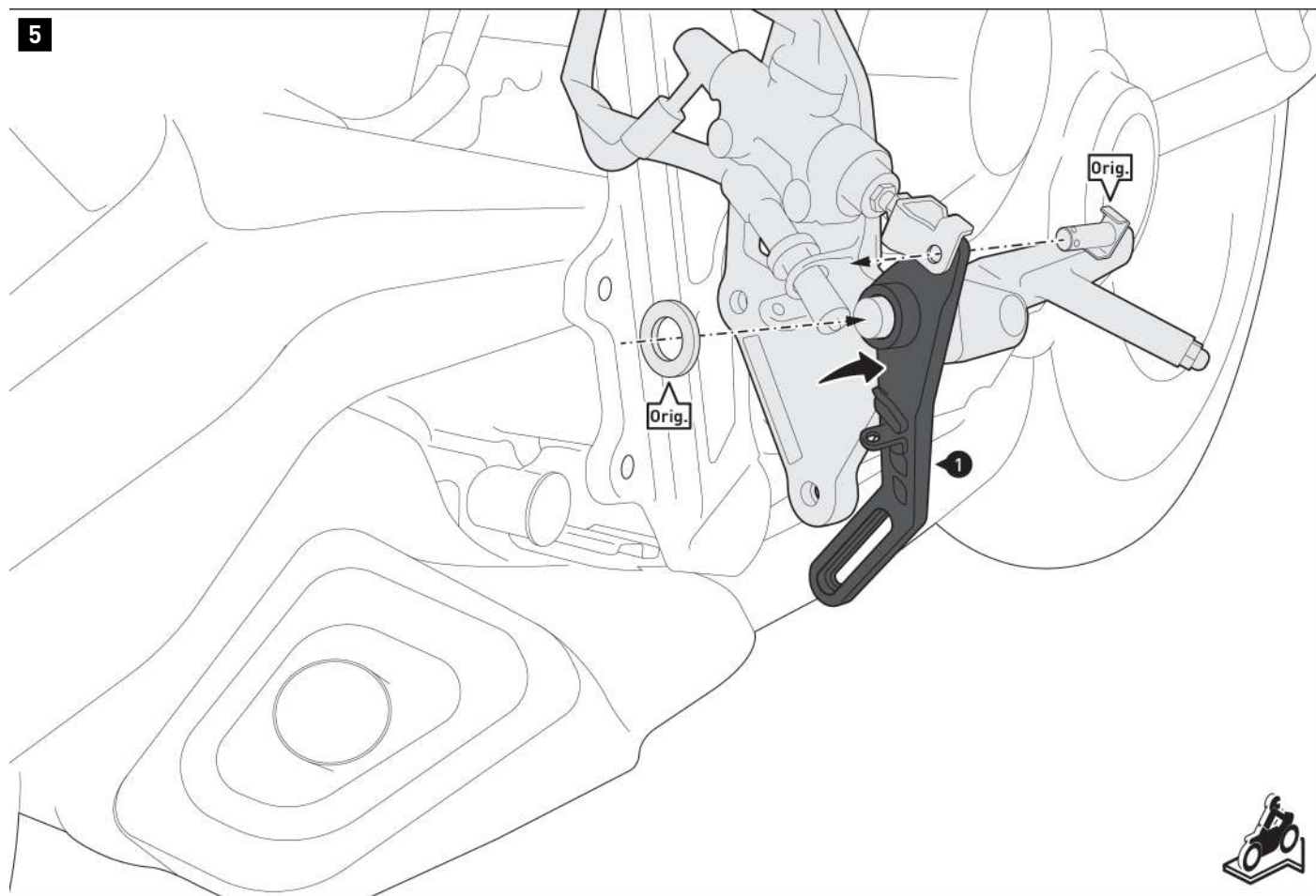

Instale el pedal de freno en el soporte del reposapiés [1] utilizando las piezas originales (Orig.).

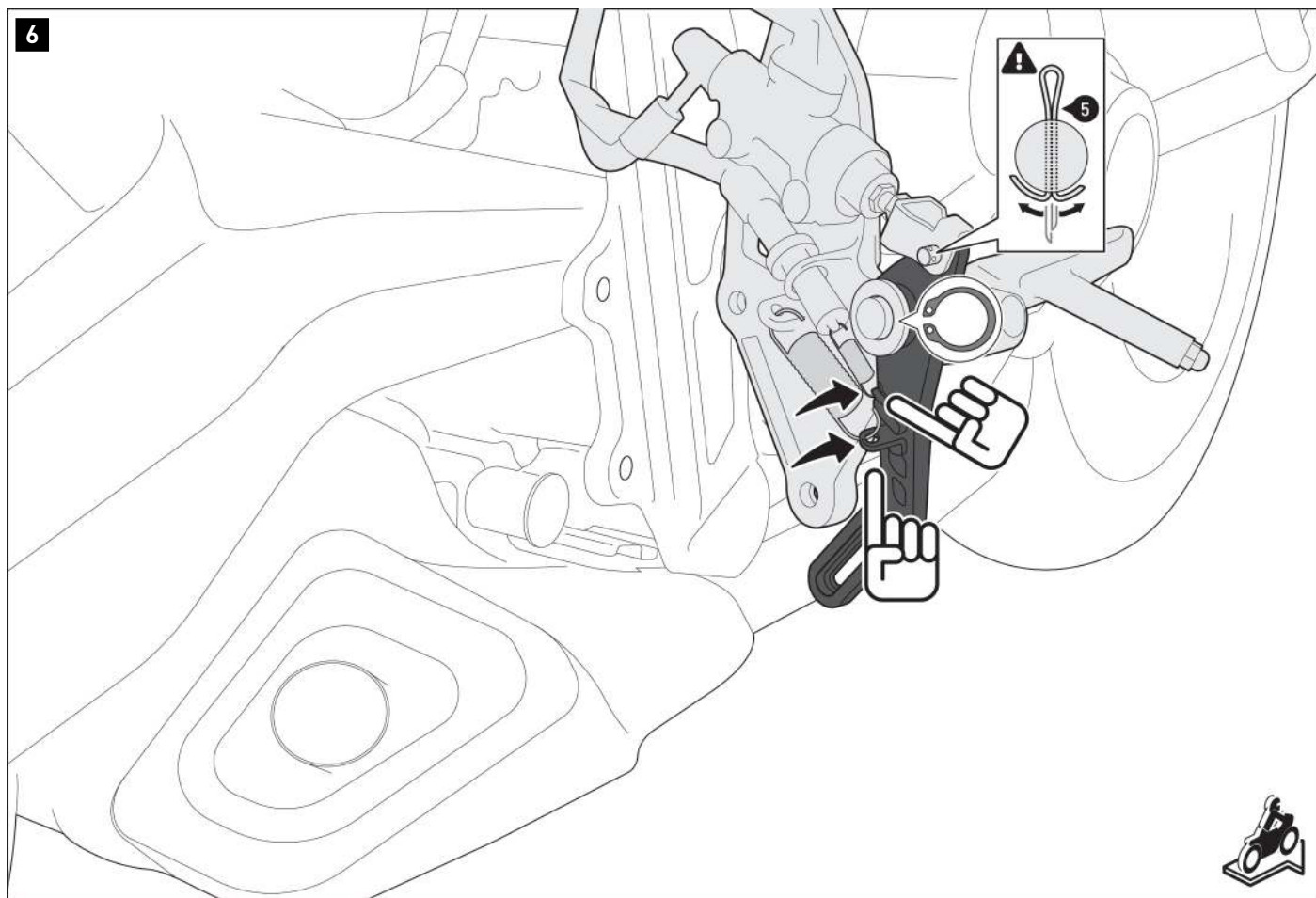

Enganche los resortes en la posición indicada.
Instale la varilla de presión original (Orig.) con la **nueva** chaveta de seguridad (5).
Instale el anillo de bloqueo original.



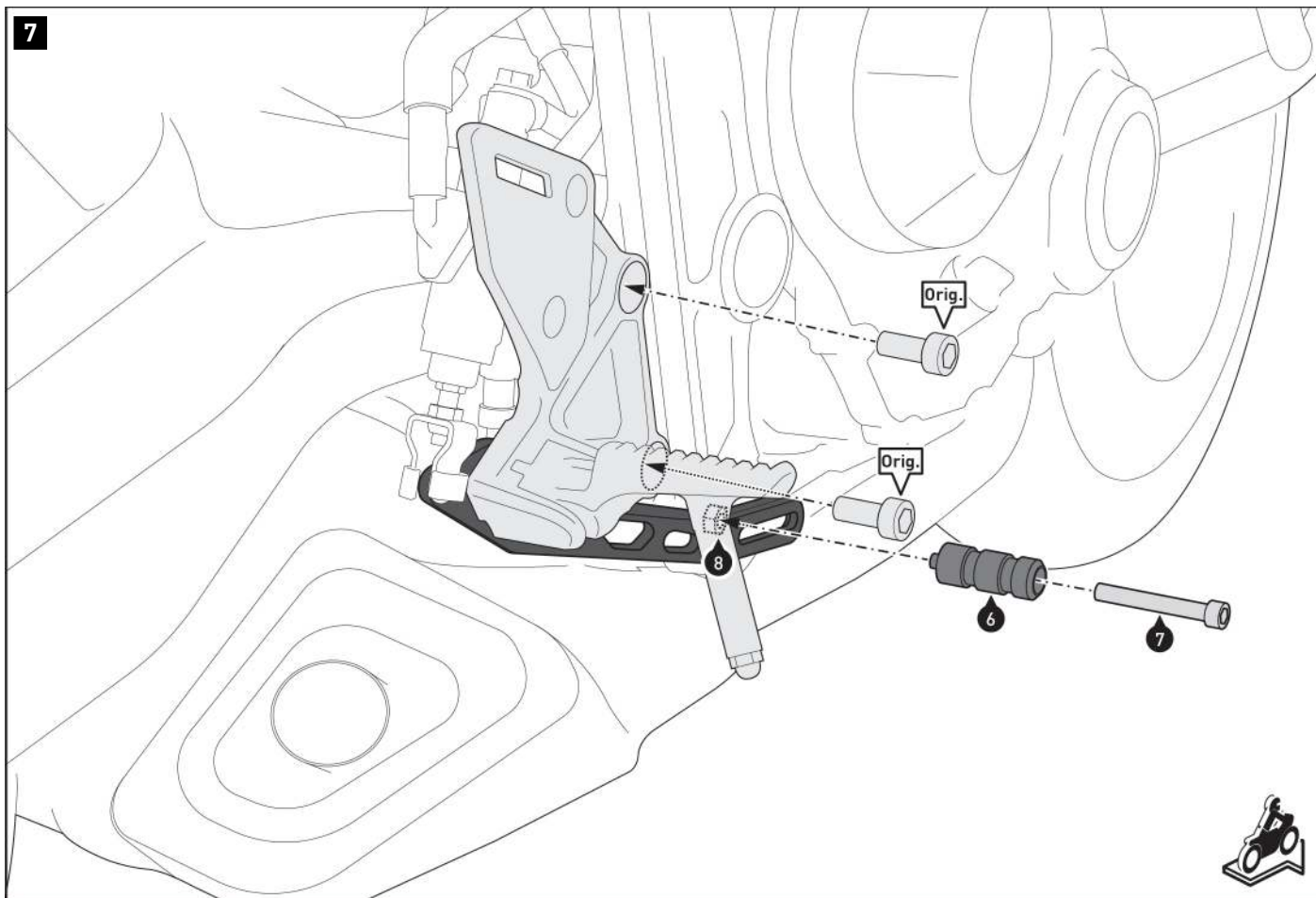

Atornille la puntera (6) al pedal de freno.
No apriete todavía el tornillo (7).

Atornille el soporte del reposapiés al vehículo utilizando los tornillos originales (Orig.).

⚠ ATENCIÓN:; Utilice un fija tornillos líquido! (solo (Orig.))
Apriete los tornillos originales (Orig.) según se indica en las instrucciones del fabricante.

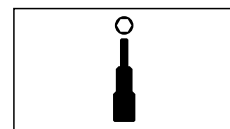
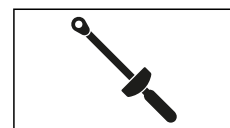

8

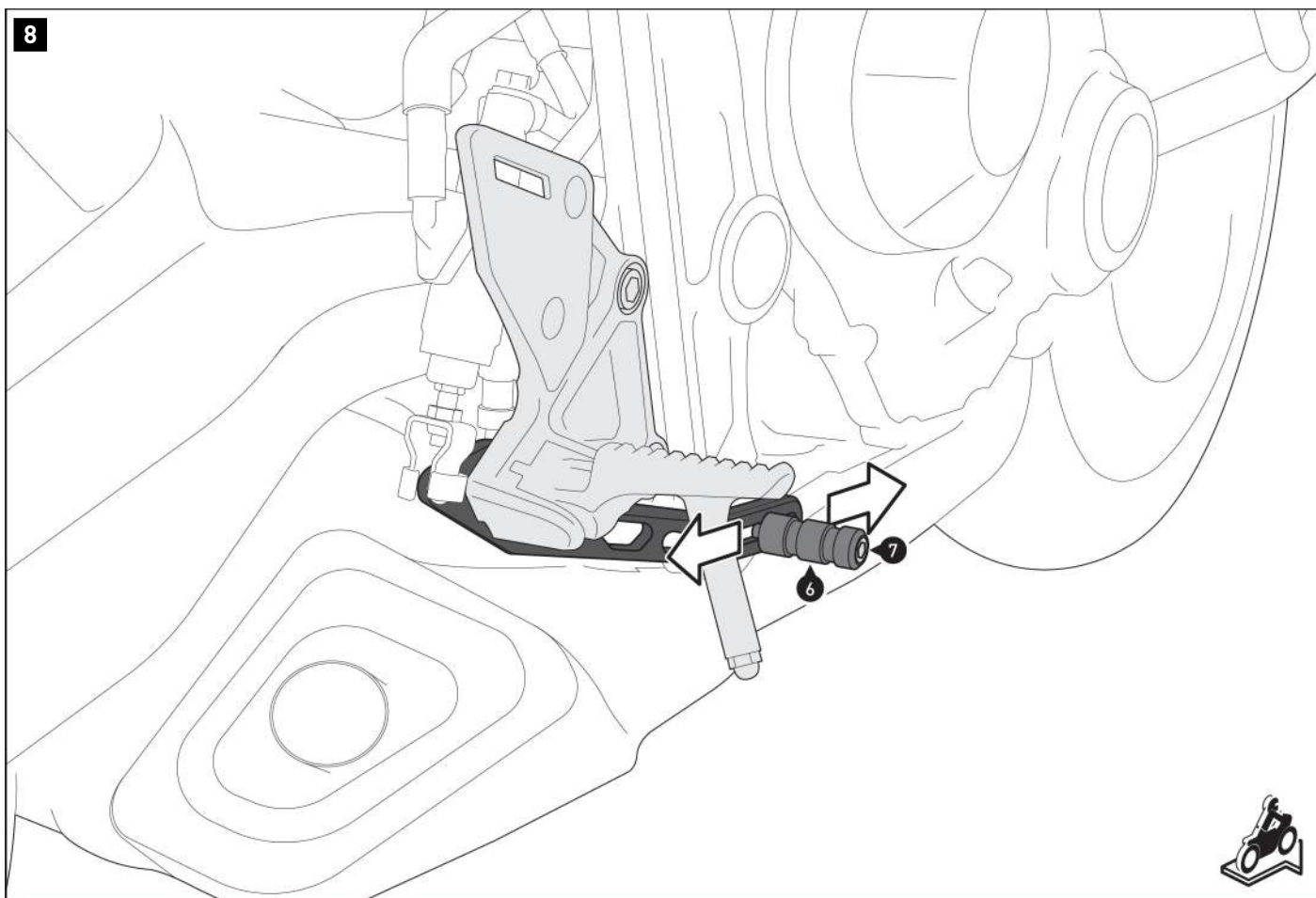

Ajuste la puntera [6] según sus hábitos de conducción.
A continuación, apriete el tornillo [7] como se especifica en las instrucciones de montaje.

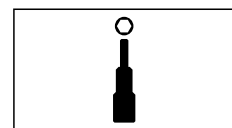
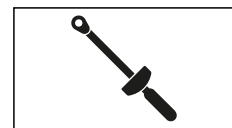

INDICACIONES ESPECÍFICAS DEL PRODUCTO

▲ PELIGRO: ¡Por último, haga que un taller especializado cualificado y certificado realice una comprobación funcional completa del sistema de frenos de su vehículo!

▲ ATENCIÓN: ¡Este producto puede reducir la distancia al suelo y en curvas en caso de una inclinación extrema!

▲ NOTA: *Deben respetarse las normas nacionales para la matriculación/uso del vehículo y las normas de inspección técnica vigentes. En caso de piezas con registro obligatorio, su organismo de inspección debe registrarlas tras el montaje en los documentos del vehículo.*

Si este producto dispone de una homologación nacional de tipo (ABE):

¡Siempre debe llevar consigo la homologación nacional de tipo suministrada con el producto! ¡Esta homologación nacional de tipo solo se aplica a los modelos indicados y en cumplimiento de todos los requisitos! ¡Para su uso en un vehículo que no figura aquí, debe realizarse el registro en los documentos del vehículo!

Las asignaciones de vehículos en el documento de la homologación nacional de tipo se amplían anualmente. Por ello, en algunas circunstancias, puede que la homologación nacional de tipo para un nuevo producto no se produzca hasta unos meses después de su lanzamiento al mercado. Si su modelo no está en la lista o si ya no dispone del documento de la homologación nacional de tipo, acceda a la sección de descargas de nuestra tienda web. La versión actual del documento de la homologación nacional de tipo está disponible allí.

Numéro d'article: **FBL.01.529.10000**Révision: **00** · Date: **09 - 2023**

Pédale de frein

 ~ 1 h.FACILE    DIFFICILE

FRANÇAIS · Nous vous remercions d'avoir choisi ce produit haut de gamme de SW-MOTECH. Visitez notre boutique en ligne pour plus d'informations (par exemple affectation des modèles). Les documents nécessaires (par exemple ABE) y sont disponibles en téléchargement.

Veillez lire et prendre en compte toutes les instructions, les consignes de sécurité et les avertissements contenus dans ce manuel de montage avant de monter et d'utiliser le produit afin d'éviter toute blessure ou tout dommage. Veuillez conserver la notice d'utilisation pour référence.

Ce produit a été développé pour des véhicules en configuration d'usine. Nous ne sommes pas en mesure d'assurer la compatibilité avec les pièces de rechange originales ou les pièces de rechange d'autres fabricants.

La présente notice d'installation a été élaborée conformément à nos connaissances actuelles. Il n'existe aucun droit juridique à l'exactitude des informations qu'elle contient. Sous réserve d'erreurs et de fautes. Sous réserve de modifications techniques et conceptuelles. SW-MOTECH détient les droits d'auteur.

SYMBOLE D'AVERTISSEMENT DE SÉCURITÉ

⚠ Ce symbole d'avertissement est utilisé dans ces instructions de montage pour mettre en garde contre des dangers mortels, de blessures ou d'autres risques. Les mots DANGER, ATTENTION ou RECOMMANDATION sont utilisés avec ce symbole d'avertissement pour transmettre des consignes de sécurité et des informations importantes concernant le montage et l'utilisation de ce produit. Ces mots, associés au symbole d'avertissement de sécurité, signifient :

⚠ DANGER : signale une situation dangereuse pouvant entraîner la mort ou des blessures graves si elle n'est pas évitée !

⚠ ATTENTION : signale une situation dangereuse pouvant entraîner la mort ou des blessures graves si elle n'est pas évitée !

⚠ PRUDENCE : Indique une situation dangereuse susceptible d'entraîner des blessures de gravité réduite ou moyenne si elle se présente !

⚠ REMARQUE : Informations importantes, mais qui n'entraînent pas de risque de décès ou de blessure (dommages matériels uniquement).

REMARQUES GÉNÉRALES

⚠ ATTENTION : le montage et/ou l'entretien de ce produit nécessite des compétences techniques avancées, des outils appropriés et une bonne compréhension de l'utilisation des outils et des indications de réglage. Pour votre propre sécurité, SW-MOTECH recommande de confier le montage et/ou l'entretien à un atelier de réparation de deux-roues qualifié et certifié.

⚠ ATTENTION : si vous décidez de monter vous-même ce produit, lisez attentivement et intégralement les instructions de montage avant le montage et l'utilisation et suivez toutes les instructions afin d'éviter des blessures graves ou mortelles. Lors du montage et de l'utilisation, tenez également compte de toutes les informations pertinentes du manuel du véhicule. **SI VOUS NE COMPRENEZ PAS UNE PARTIE DE CE MANUEL D'INSTALLATION OU SI VOUS AVEZ BESOIN D'EXPLICATIONS CONCERNANT UNE INSTRUCTION, N'ESSAYEZ PAS D'INSTALLER CE PRODUIT SANS DEMANDER DE L'AIDE À SW-MOTECH !**

PRÉPARATION : Veuillez lire attentivement les instructions de montage et assurez-vous que tous les éléments de la liste de pièces sont présents.

⚠ PRUDENCE : veillez à ce que votre véhicule soit bien stable. Éteignez le moteur et retirez la clé de contact. Laissez refroidir le moteur/l'échappement si nécessaire. Débranchez la batterie lorsque vous travaillez sur le système électrique. Utilisez uniquement des outils appropriés et portez toujours des lunettes de protection et des gants pendant le montage et l'entretien. Faites-vous aider par une deuxième personne lors du montage et de l'entretien.

MONTAGE : Toutes les pièces et connexions retirées du véhicule doivent être réinstallées conformément aux instructions du fabricant du véhicule ou remplacées par des pièces et du matériel fournis par SW-MOTECH.

⚠ ATTENTION Sauf indication contraire, sécurisez tous les filetages avec du frein filet liquide de force moyenne.

⚠ DANGER : Les couples de serrage non définis par SW-MOTECH doivent être obtenus auprès du constructeur du véhicule ou d'un atelier de réparation de motos certifié.

CONTRÔLE DU FONCTIONNEMENT : Après le montage, assurez-vous qu'aucune pièce mobile n'est bloquée et que le fonctionnement du véhicule n'est pas perturbé. Les câbles et les tuyaux ne doivent pas frotter et/ou être coincés.

⚠ ATTENTION : Effectuez un contrôle de fonctionnement complet avant de commencer à rouler. Après les 50 premiers kilomètres, puis régulièrement, vérifiez le couple de serrage de tous les raccords et la bonne fixation du produit. Les accessoires montés peuvent modifier le comportement sur la route et la stabilité du véhicule.



SW-MOTECH GmbH & Co. KG
Ernteweg 7-10
35282 Rauschenberg
Allemagne



info@sw-motech.com
www.sw-motech.com



Vous trouverez les symboles et leur signification dans la section MONTAGE. Si le terme OEM apparaît dans la section MONTAGE, il faut respecter et appliquer les consignes du fabricant du véhicule.



Si vous avez des questions, notre service clientèle ainsi que nos distributeurs se tiennent à votre disposition. Vous trouverez notre numéro de téléphone ainsi que la liste de nos distributeurs sur notre boutique en ligne : www.sw-motech.com



Utilisez du frein filet : Indique qu'un filetage doit être enduit de frein filet liquide. H (HIGH) : haute résistance ; M (MEDIUM) : force moyenne ; L (LOW) : faible résistance.



Serrer en respectant les instructions de couple de serrage : indique le couple de serrage d'une pièce prescrit par SW-MOTECH ou par le fabricant du véhicule (OEM).



Ne pas utiliser de frein filet : signifie que l'utilisation d'un frein filet liquide n'est pas nécessaire à ce stade.

LISTE DES PIÈCES - LIRE ET CONSERVER LES INSTRUCTIONS DE MONTAGE!

4

1



FBL.01.529.900.01.02

 1/1

2



FBL.01.529.003.03

 1/1

3



FBL.01.529.004.03

 1/1

4



M4 x 8; ISO 7380
SC.ST.04.008.02.73800.109

 4/4

6

5



SP.ST.020.016.01.94

 1/1

7

6



FBL.00.127.003.36

 1/1

7



M6 x 50; DIN 912
SC.ST.06.050.01.912.088

 1/1

8



M6; DIN 985
MU.ST.06.01.985.08

 1/1

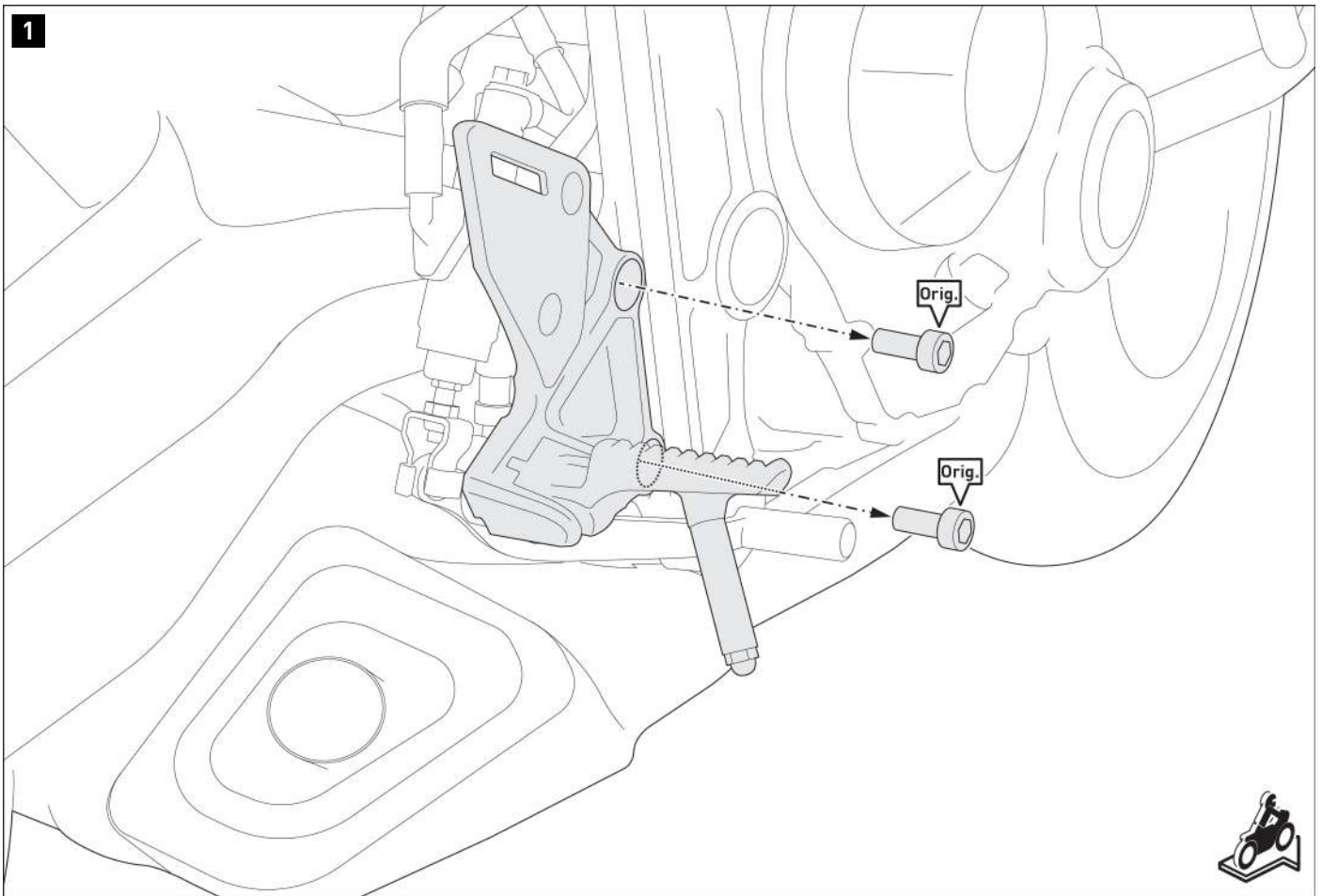

⚠ DANGER : Une pédale de frein est un accessoire important pour la sécurité !
Pour votre sécurité, SW-MOTECH recommande de confier l'installation et/ou l'entretien à un atelier spécialisé qualifié et certifié.

⚠ ATTENTION : Portez toujours une protection pour les yeux et les mains !
⚠ ATTENTION : Utilisez toujours des outils adaptés !

⚠ REMARQUE : Avant de démonter le levier de frein d'origine, notez l'ordre et l'orientation des pièces d'origine.

Retirez les vis illustrées du support de repose-pied droit.

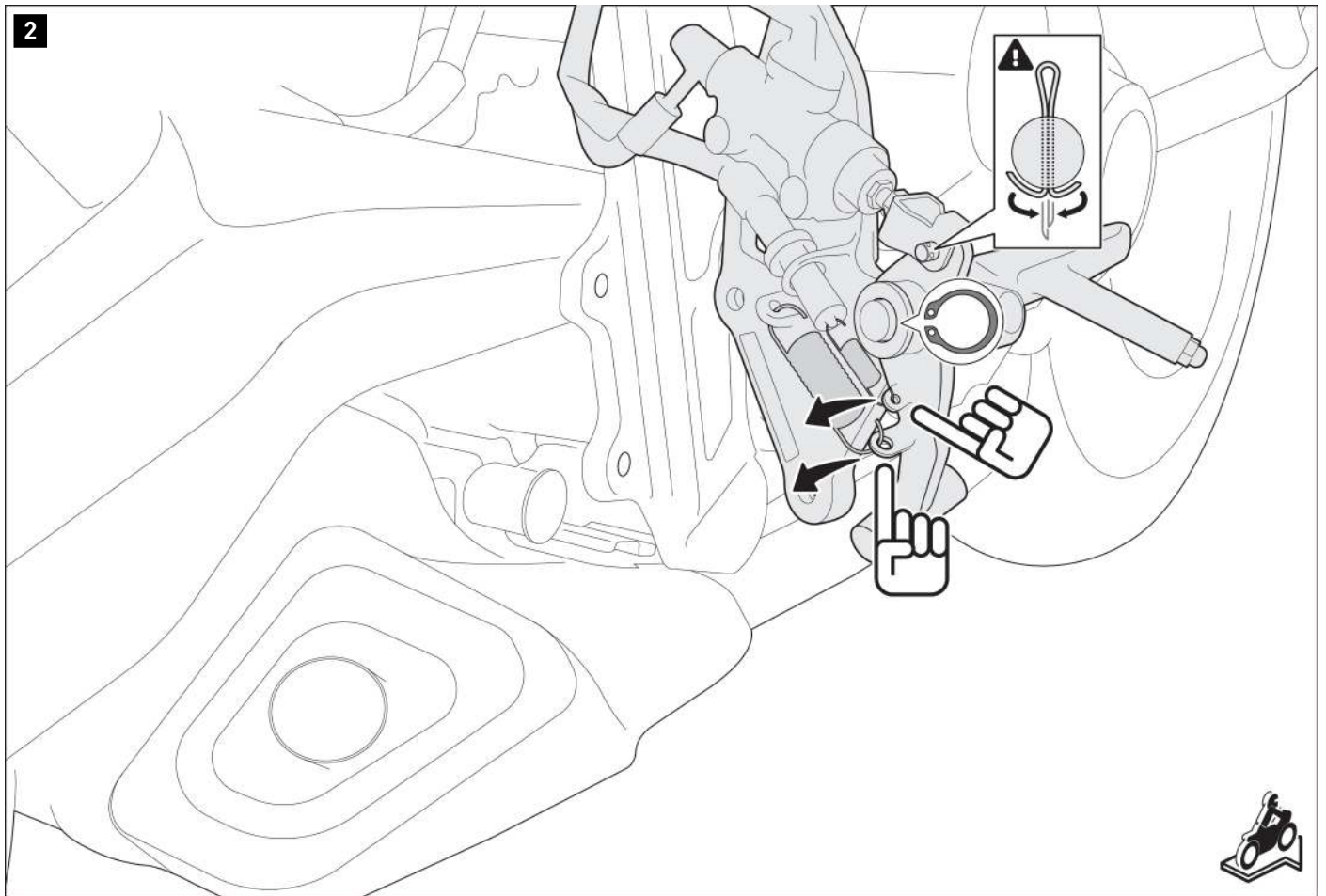

Desserrez la goupille fendue de la tige de poussée du maître-cylindre.
Décrochez les ressorts indiqués.
Retirez la bague de verrouillage.

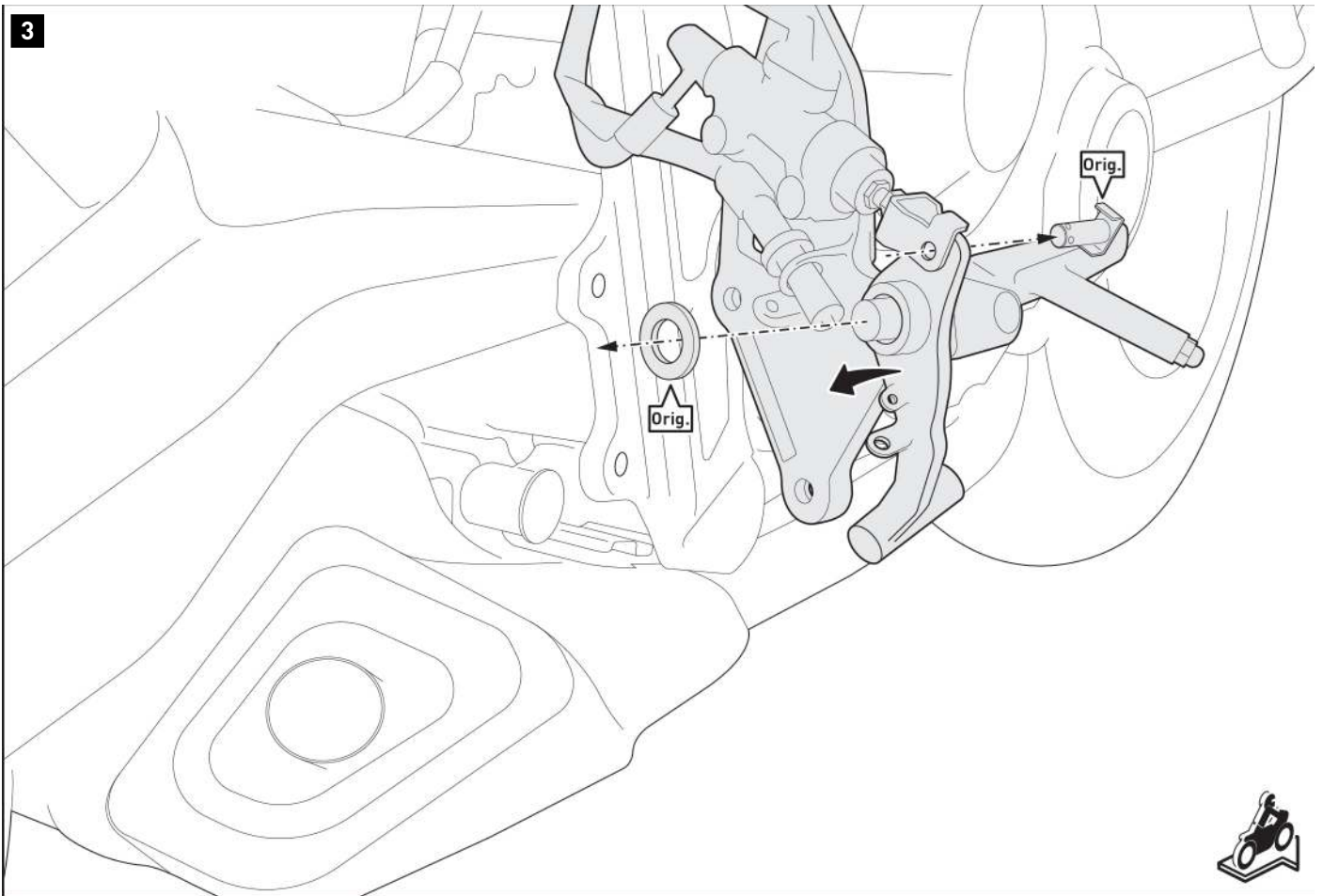

Retirez la pédale de frein d'origine du support de repose-pieds.

4

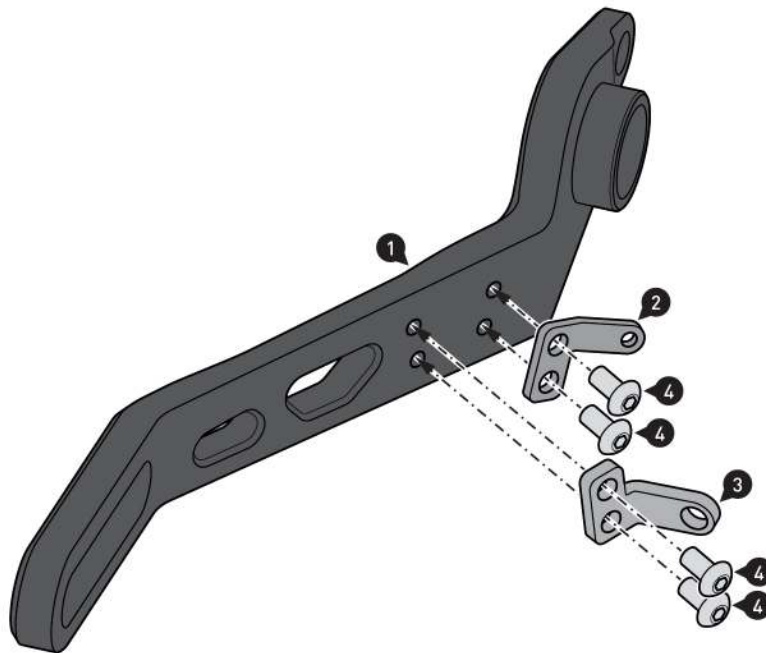

Vissez les pièces illustrées ensemble.

▲ ATTENTION : utilisez un fusible à vis liquide !

Serrez les vis (4) comme indiqué dans les instructions de montage.



M 2,8 Nm

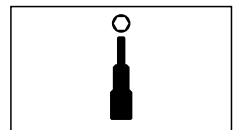
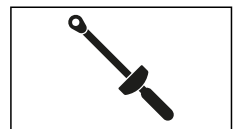

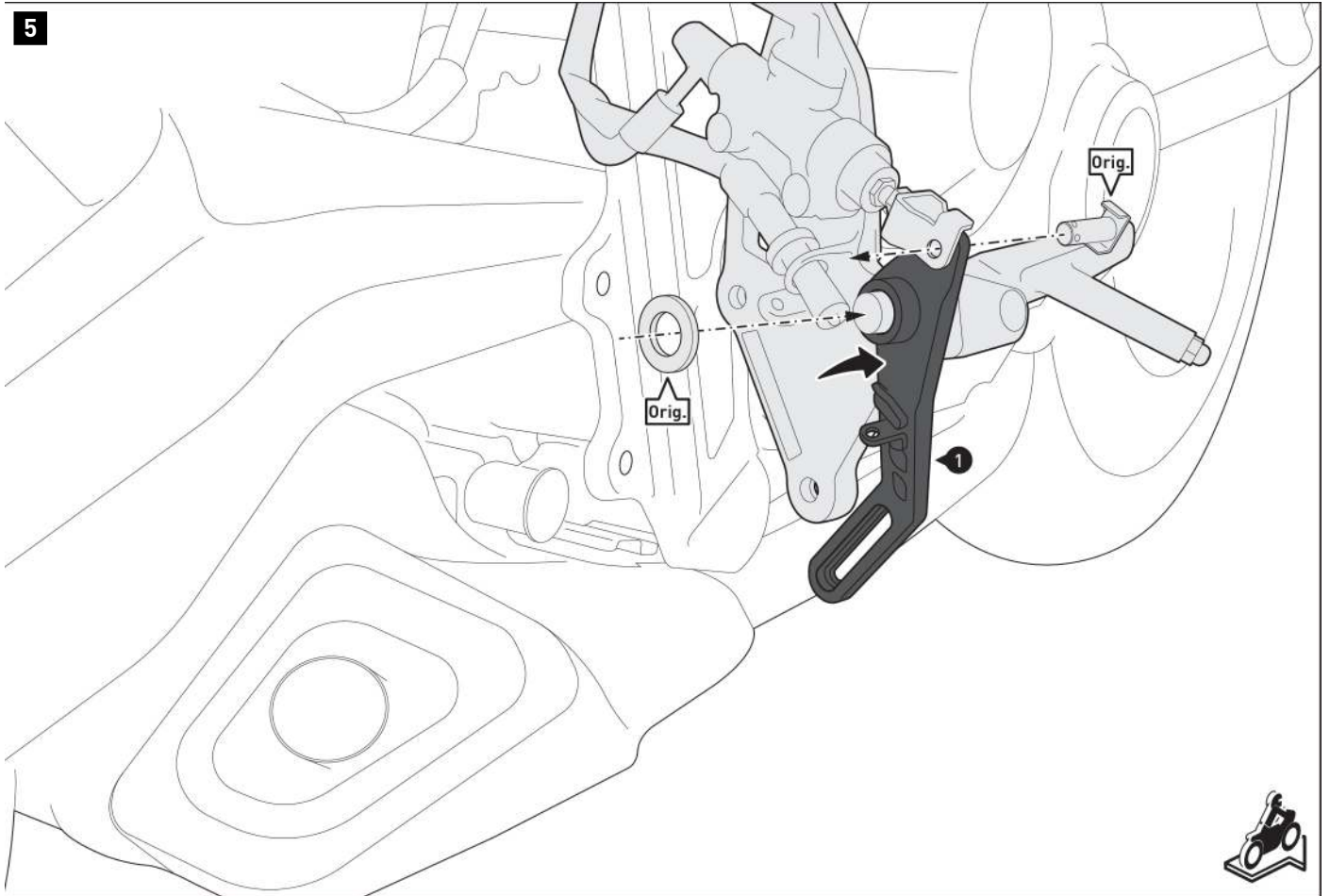

Montez la pédale de frein (1) avec les pièces d'origine (Orig.) sur le support de repose-pieds.

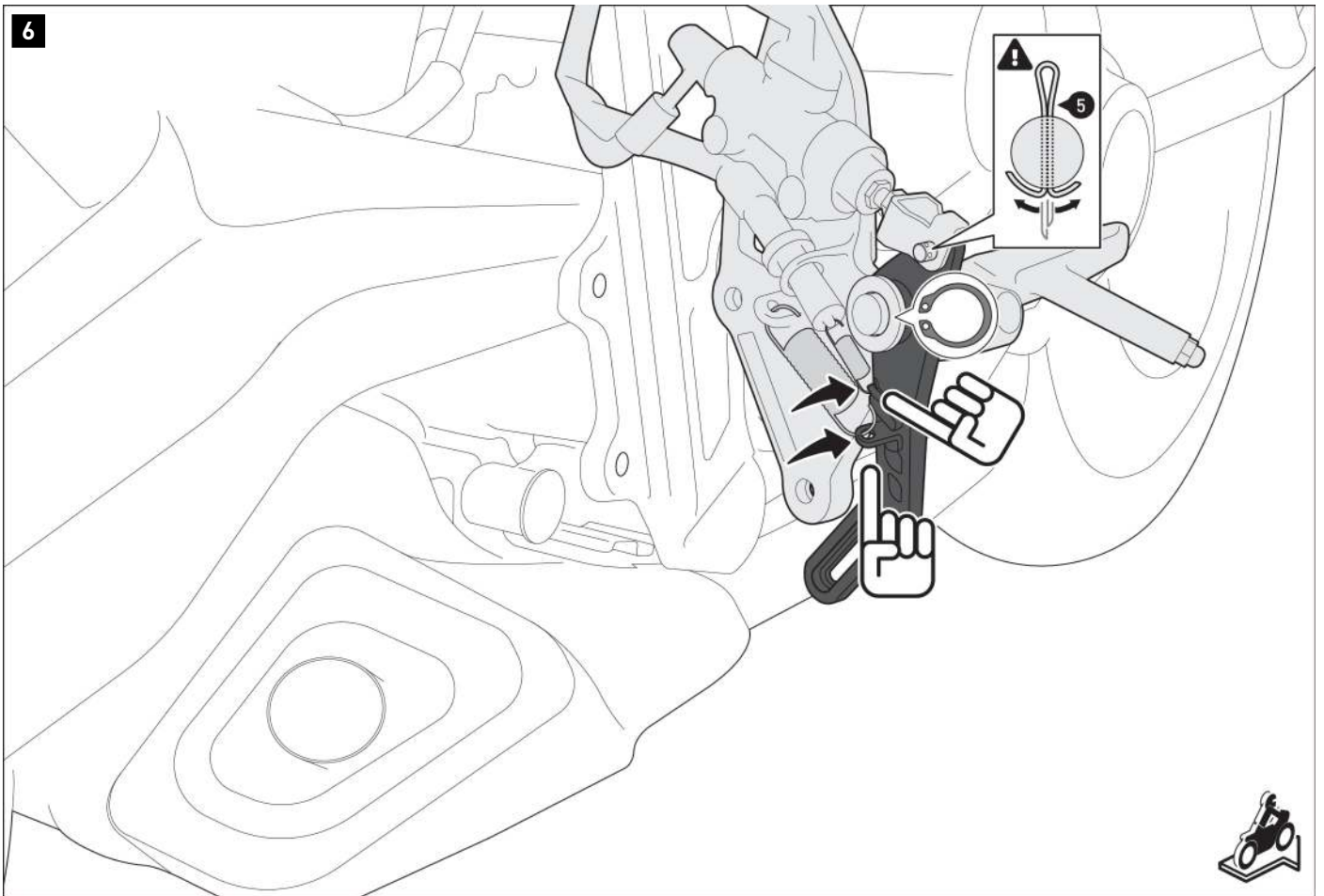

Accrochez les ressorts dans la position indiquée.
Montez la tige de pression d'origine (Orig.) avec la **nouvelle** goupille de sécurité [5].
Montez la bague de verrouillage d'origine.



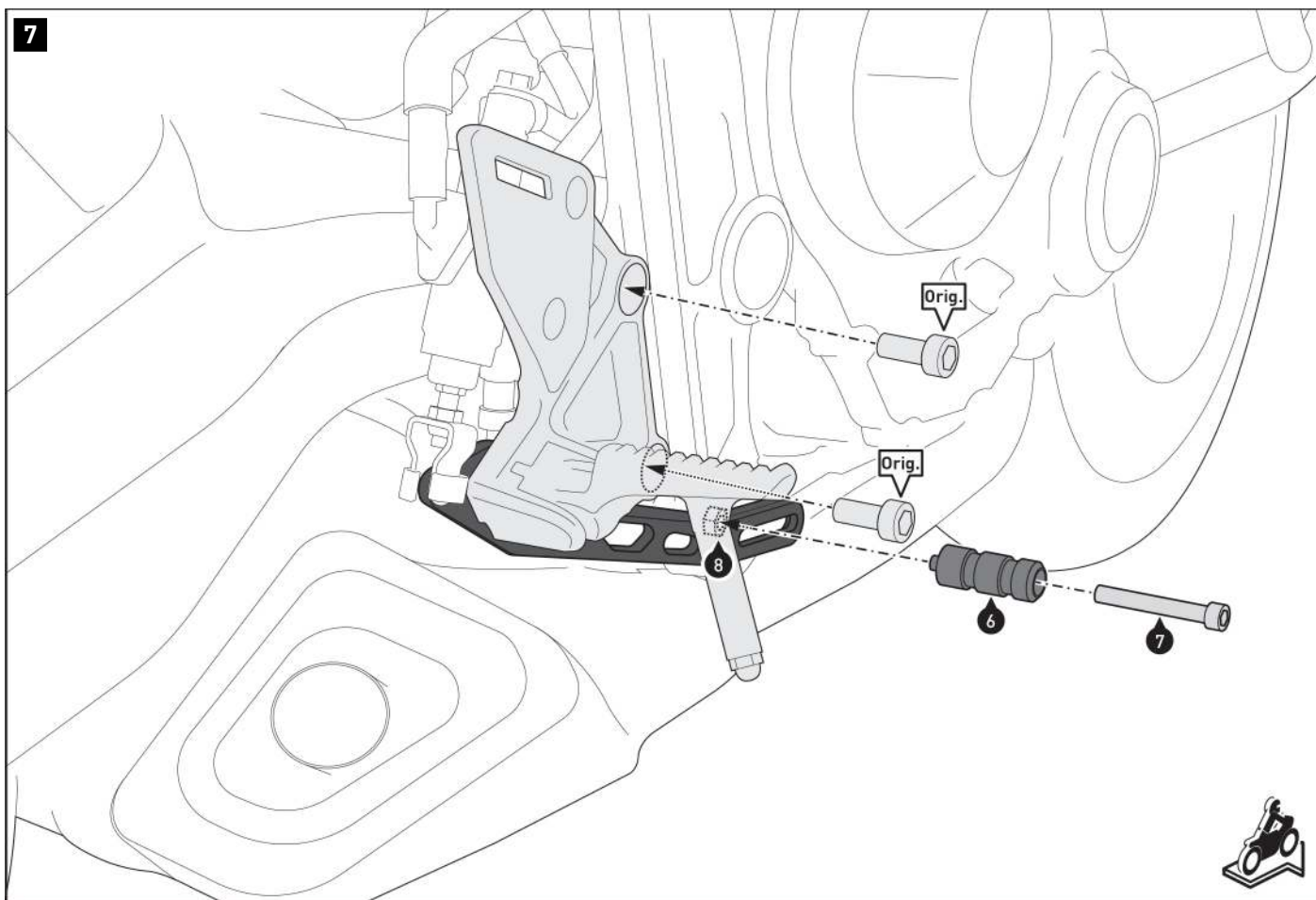

Vissez la pédale (6) sur la pédale de frein.
Ne serrez pas encore la vis (7).

Vissez le support de repose-pieds au véhicule avec les vis d'origine (Orig.).
▲ ATTENTION :utilisez du frein filet liquide ! (uniquement (Orig.))
Serrez les vis d'origine (Orig.) selon les instructions du fabricant.

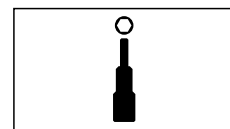
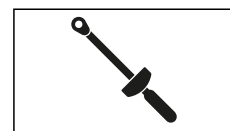

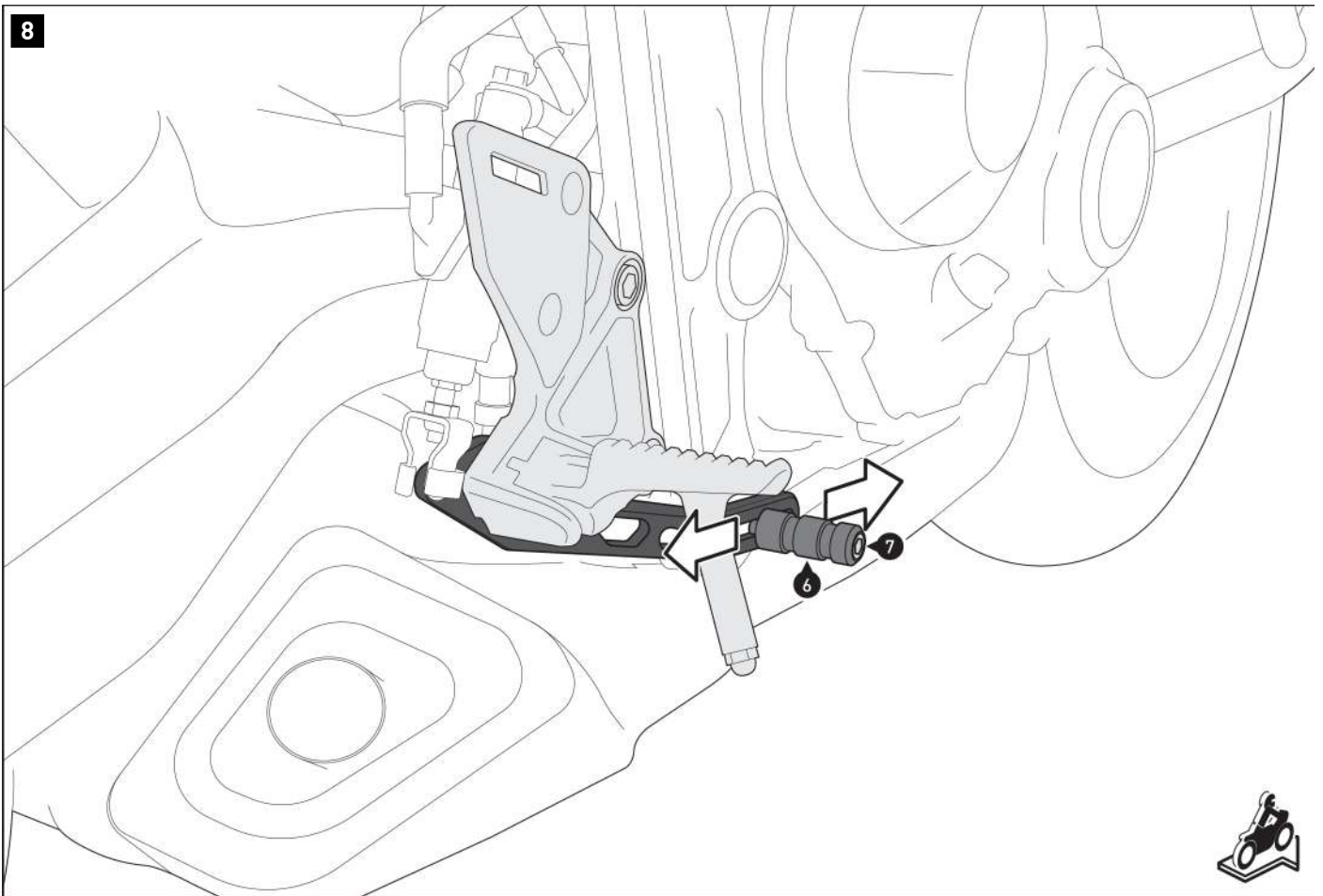

Ajustez la pédale (6) en fonction de vos habitudes de conduite.
Serrez ensuite la vis (7) comme indiqué dans les instructions de montage.

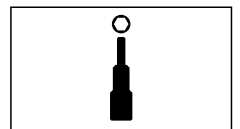

REMARQUES SPÉCIFIQUES AU PRODUIT

▲ DANGER : Faites effectuer un contrôle fonctionnel complet du système de freinage de votre véhicule par un atelier spécialisé qualifié et certifié !

▲ ATTENTION : Les virages et la garde au sol peuvent être limités par ce produit en cas d'inclinaison extrême !

▲ REMARQUE : Respectez les réglementations spécifiques au pays pour l'immatriculation/l'utilisation de votre véhicule ou les réglementations TÜV applicables. Après le montage, faites inscrire les pièces soumises à immatriculation dans les papiers du véhicule par votre centre de contrôle.

Si une homologation de circulation nationale (ABE) est disponible pour ce produit :

L'ABE livré avec le produit doit toujours être sur vous ! Cet ABE s'applique uniquement aux modèles répertoriés et conformes à toutes les exigences ! Pour une utilisation sur le véhicule non répertorié ici, l'inscription doit être faite dans les papiers du véhicule !

Les affectations de véhicules dans le document ABE sont élargies chaque année. De ce fait, l'ABE d'un nouveau produit peut n'intervenir que quelques mois après la mise sur le marché. Si votre modèle n'est pas répertorié ou si vous n'avez plus le document ABE, veuillez visiter la section de téléchargement de notre boutique en ligne. La version actuelle du document ABE y est disponible.

Numero di articolo: **FBL.01.529.10000**Revisione: **00** · Data: **09 - 2023****Pedale freno** ~ 1 h.FACILE     DIFFICILE

ITALIANO -Grazie per aver scelto questo prodotto premium di SW-MOTECH. Visita il nostro negozio online per ulteriori informazioni (ad es. per la compatibilità con i vari modelli). I documenti richiesti (ad es. certificato di omologazione nazionale) possono essere scaricati qui.

Si prega di leggere attentamente le avvertenze di sicurezza e le istruzioni per il montaggio prima di montare e utilizzare il prodotto, al fine di evitare eventuali lesioni e danni. Conserva queste istruzioni per il montaggio come riferimento futuro.

Questo prodotto è stato sviluppato per veicoli in condizioni di fabbrica. La compatibilità con gli accessori originali o di altri produttori non può essere garantita.

Queste istruzioni per il montaggio sono state redatte in base alle nostre conoscenze attuali. Non sussistono pretese di correttezza giuridiche. Salvo errori ed omissioni. Ci riserviamo il diritto di apportare modifiche tecniche e di design. Copyright SW-MOTECH.

SIMBOLO DI SICUREZZA

 Questo simbolo di avvertenza è usato nelle presenti istruzioni di montaggio per segnalare pericoli mortali, rischio di lesioni o altri pericoli. Le parole "PERICOLO", "AVVERTENZA" O "ATTENZIONE" sono utilizzate con questo simbolo di avvertenza per trasmettere importanti istruzioni di sicurezza e informazioni relative al montaggio e all'uso di questo prodotto. Queste parole, utilizzate insieme al simbolo di avvertenza, significano:

▲ PERICOLO: indica una situazione di pericolo che, se non evitata, può causare morte o lesioni gravi!

▲ AVVERTENZA: indica una situazione di pericolo che, se non evitata, può causare morte o lesioni gravi!

▲ ATTENZIONE: indica una situazione di pericolo che, se non evitata, può provocare lesioni lievi o di entità moderata!

▲ AVVISO: indica informazioni importanti che non riguardano il rischio di morte o di lesioni (riguardano unicamente il rischio di danni materiali)!

INFORMAZIONI GENERALI

▲ AVVERTENZA: il montaggio e/o la manutenzione di questo prodotto richiedono competenze tecniche avanzate, strumenti adeguati e una buona conoscenza dell'uso della strumentazione e delle indicazioni relative alle coppie di serraggio. Per ragioni di sicurezza, SW-MOTECH raccomanda di far eseguire il montaggio e/o la manutenzione presso un'officina per motociclette qualificata e certificata.

▲ AVVERTENZA: se si decide di installare questo prodotto in autonomia, leggere attentamente le istruzioni per il montaggio prima del montaggio e dell'uso e seguire tutte le avvertenze per evitare lesioni gravi o mortali. Durante il montaggio e l'uso, seguire anche tutte le istruzioni pertinenti contenute nel manuale del veicolo. **SE NON SI COMPRENDONO TALI ISTRUZIONI, ANCHE SOLO IN PARTE, O SE SONO NECESSARI CHIARIMENTI, NON CERCARE DI MONTARE IL PRODOTTO IN AUTONOMIA SENZA CHIEDERE IL SUPPORTO DI SW-MOTECH!**

PREPARAZIONE: leggere attentamente le istruzioni per il montaggio e assicurarsi che siano disponibili tutti i componenti contenuti nella lista.

▲ ATTENZIONE: assicurarsi che il veicolo sia perfettamente fermo. Spegner il motore e togliere la chiave. Se necessario, lasciar raffreddare il motore/lo scarico. Scollegare la batteria quando si interviene sull'impianto elettrico. Usare esclusivamente strumenti idonei e indossare sempre occhiali e guanti protettivi durante le operazioni di montaggio e manutenzione. Chiedere aiuto a una seconda persona durante le fasi di montaggio e manutenzione.

MONTAGGIO: tutti i componenti e i collegamenti rimossi dal veicolo devono essere reinstallati secondo le specifiche del produttore del veicolo o sostituiti con componenti e attrezzatura forniti da SW-MOTECH.

▲ AVVERTENZA: fissare tutte le filettature con frenafili liquido a media resistenza, se non diversamente specificato.

▲ PERICOLO: le coppie di serraggio non definite da SW-MOTECH devono essere richieste al costruttore del veicolo o a un'officina certificata.

CONTROLLO DI FUNZIONALITÀ: dopo il montaggio accertarsi che non vi siano parti mobili bloccate e che il funzionamento del veicolo non sia compromesso. I cavi e i tubi flessibili non devono sfregare e/o essere schiacciati.

▲ AVVERTENZA: eseguire un controllo completo delle funzioni prima di mettersi alla guida. Controllare la coppia di serraggio di tutti i collegamenti e la tenuta del prodotto dopo i primi 50 km e in seguito regolarmente. Gli accessori montati possono modificare la maneggevolezza e la stabilità del veicolo.



SW-MOTECH GmbH & Co. KG
Ernteweg 7-10
35282 Rauschenberg
Germania



info@sw-motech.com
www.sw-motech.com



Consultare i simboli e il loro significato nella sezione MONTAGGIO. Se nella sezione montaggio compare la sigla OEM, è necessario rispettare e applicare le specifiche del produttore del veicolo.



Per qualsiasi domanda, non esitare a contattare il nostro servizio clienti o i nostri distributori. Il nostro numero di telefono e l'elenco dei nostri distributori sono disponibili nel nostro negozio online:

www.sw-motech.com



Usare un frenafiletto: indica che la filettatura deve essere rivestita con un frenafiletto liquido. H (ALTA): alta resistenza; M (MEDIA): media resistenza; L (BASSO): bassa resistenza.



Serraggio / rispetto delle specifiche sulla coppia di serraggio: indica la coppia di serraggio di un componente specificata da SW-MOTECH o dal produttore del veicolo (OEM).



Non utilizzare il frenafiletto: segnala di non dover utilizzare il frenafiletto liquido in quel determinato punto.

ELENCO DELLE PARTI - LEGGI E CONSERVA LE ISTRUZIONI DI MONTAGGIO!

4

1



FBL.01.529.900.01.02

 1/1

2



FBL.01.529.003.03

 1/1

3



FBL.01.529.004.03

 1/1

4



M4 x 8; ISO 7380
SC.ST.04.008.02.73800.109

 4/4

6

5



SP.ST.020.016.01.94

 1/1

7

6



FBL.00.127.003.36

 1/1

7



M6 x 50; DIN 912
SC.ST.06.050.01.912.088

 1/1

8



M6; DIN 985
MU.ST.06.01.985.08

 1/1

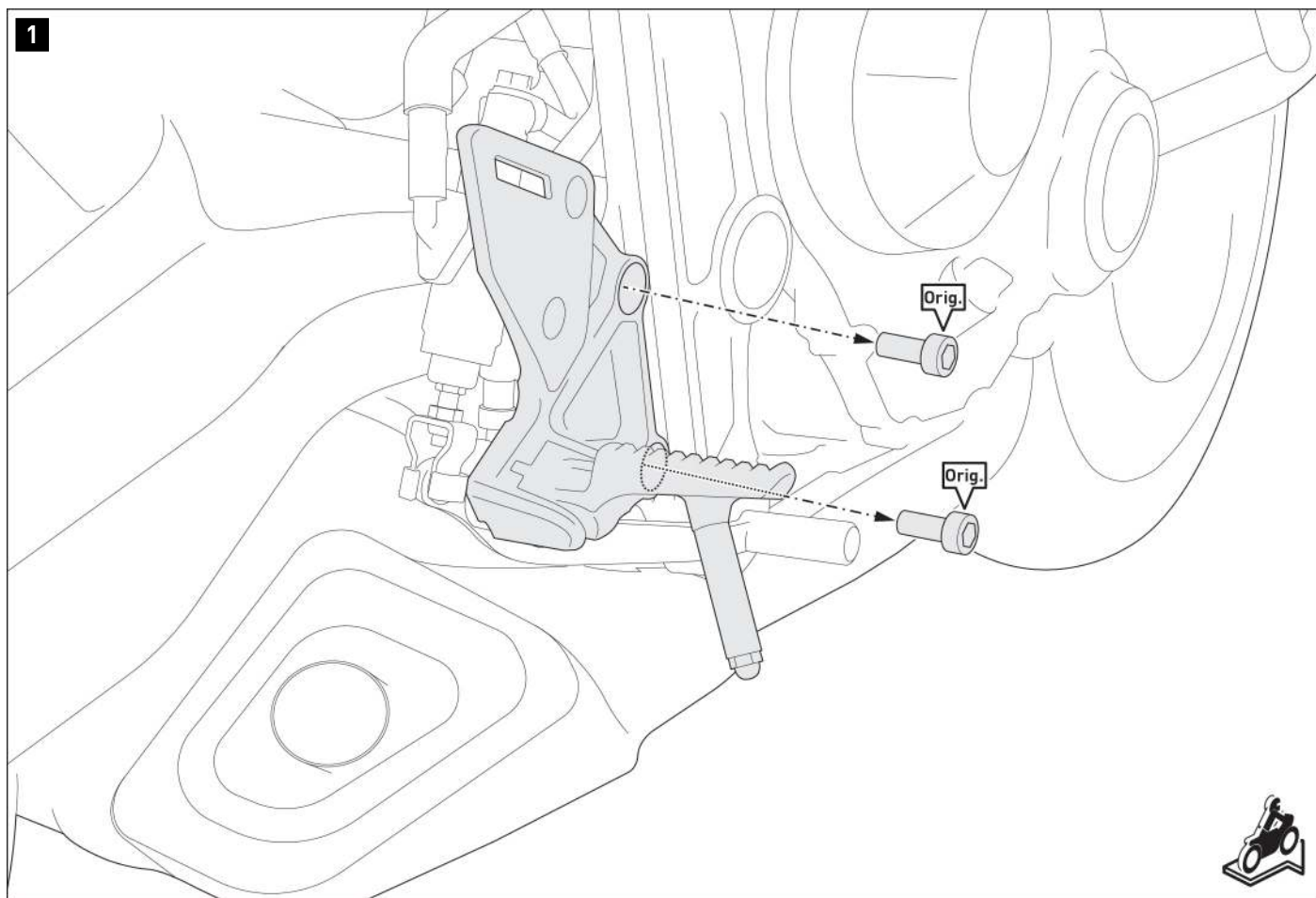

⚠ PERICOLO: La leva del freno è un accessorio importante per la sicurezza!
Per la tua sicurezza SW-MOTECH raccomanda di far eseguire l'installazione
e/o la manutenzione da un'officina specializzata qualificata e certificata!

⚠ AVVERTENZA: Indossare sempre una protezione per occhi e mani!
⚠ AVVERTENZA: Utilizzare sempre strumenti adeguati!

⚠ AVVISO: prima di smontare la leva del freno originale, annotare l'ordine e
l'orientamento delle parti originali.

Rimuovere le viti indicate dal supporto della pedana destra.

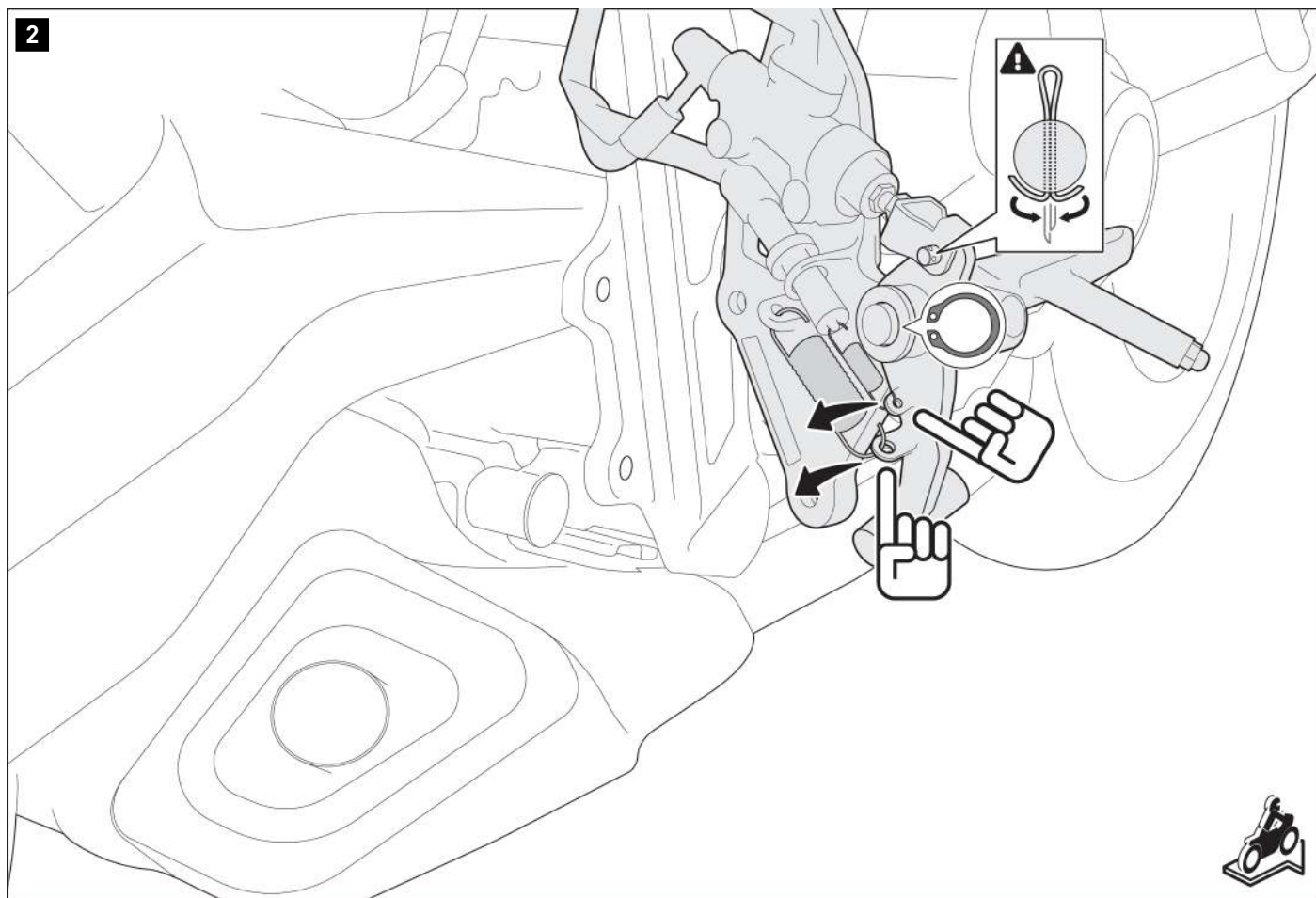

Allentare la coppiglia dall'asta di spinta del cilindro principale del freno.
Sganciare le molle indicate.
Rimuovere l'anello di bloccaggio.

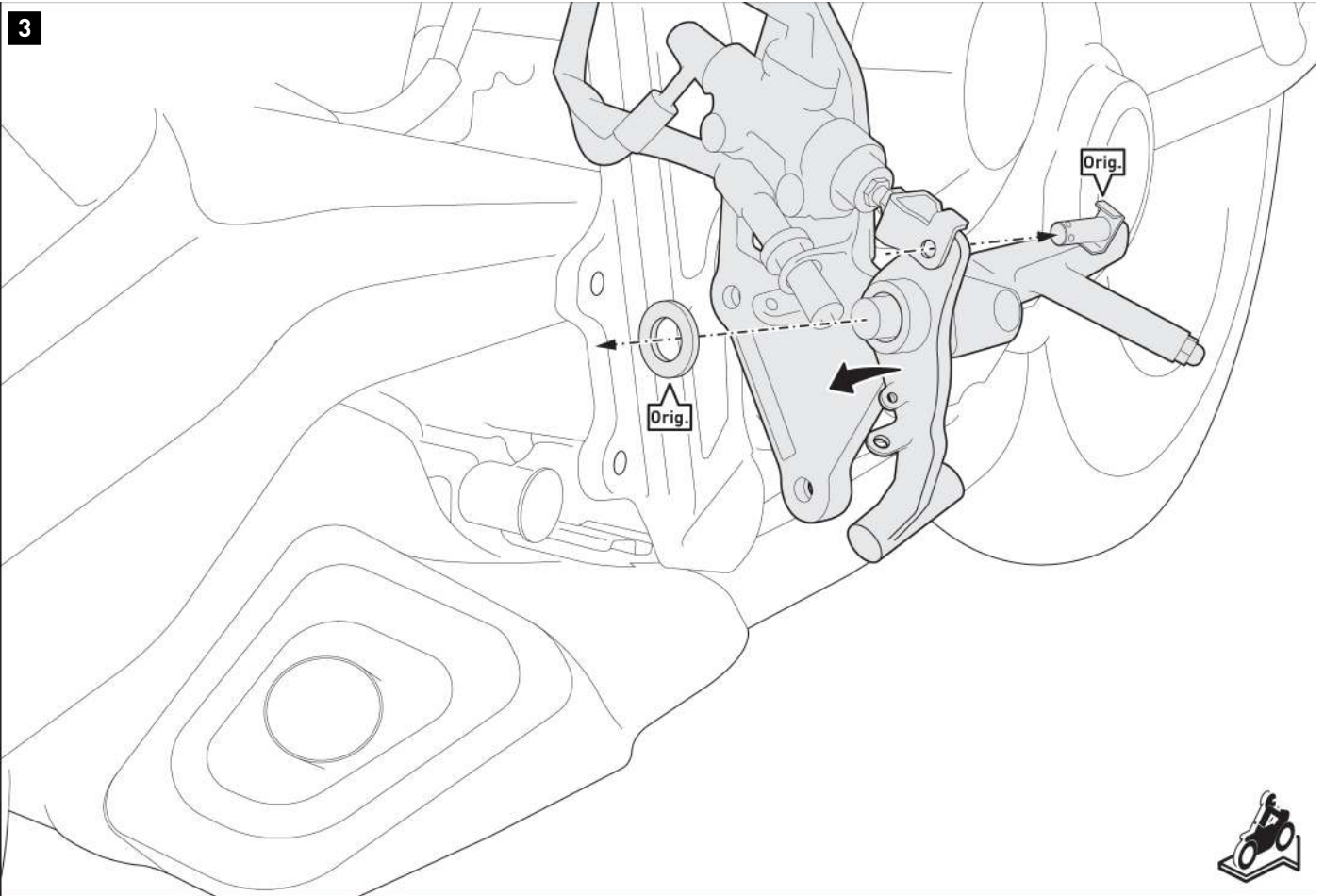

Rimuovere la leva del freno originale dal supporto della pedana.

4

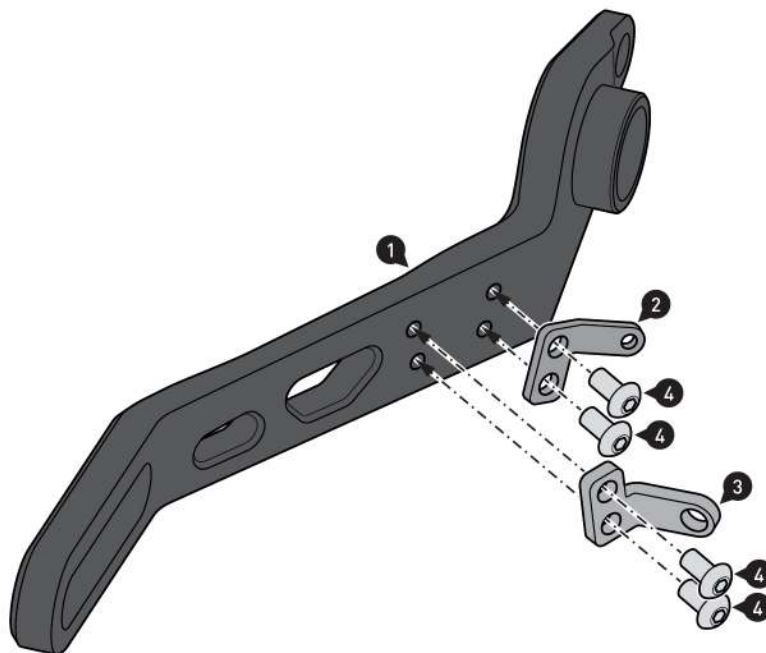

Avvitare insieme le parti indicate.

▲ AVVERTENZA: Usare un frenafilietti liquido!

Serrare le viti (4) come specificato nelle istruzioni per il montaggio.

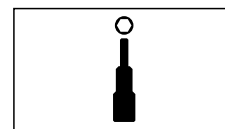
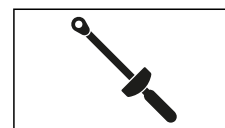
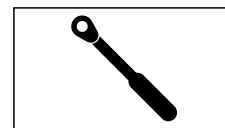

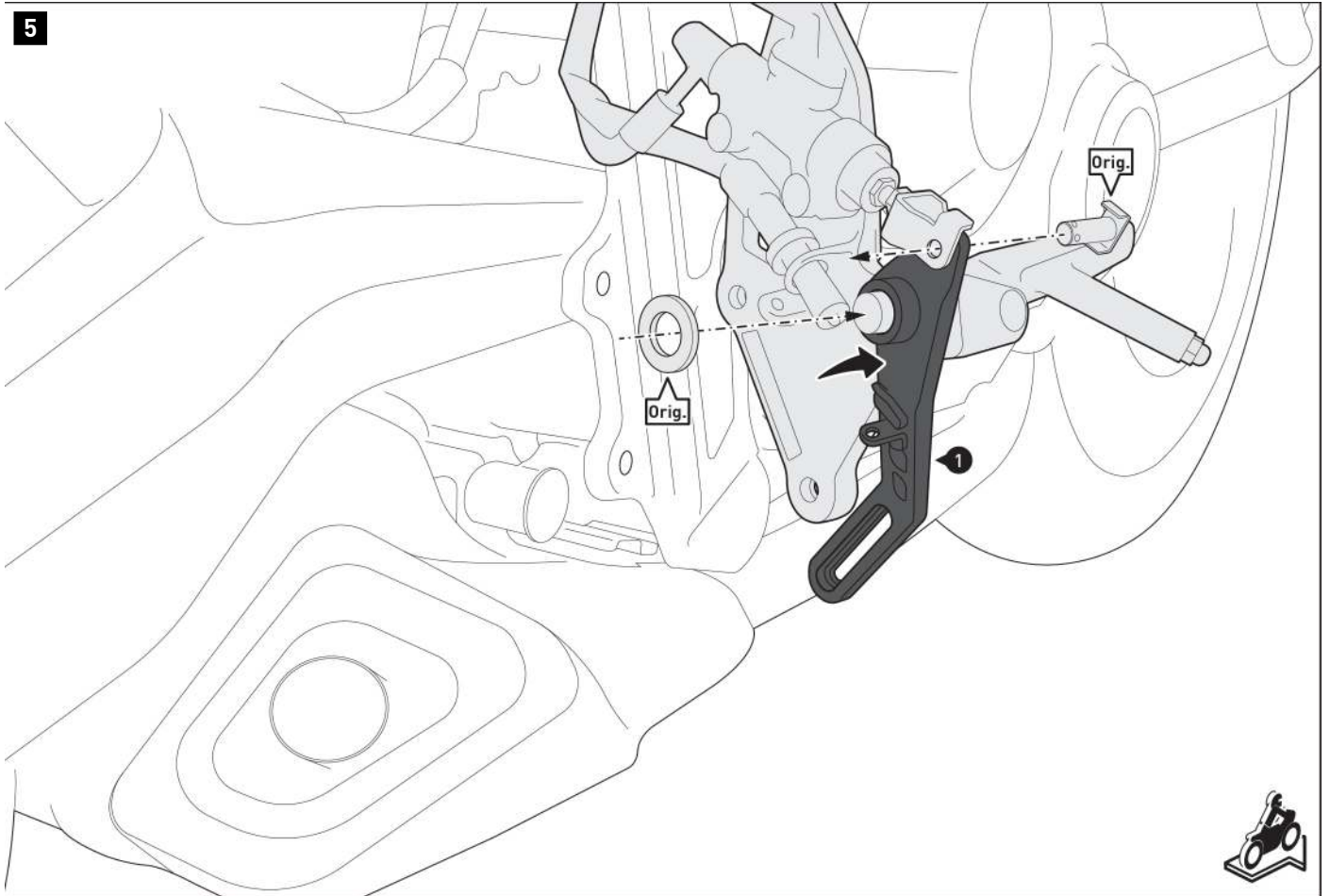

Installare la leva del freno (1) utilizzando i componenti originali (Orig.) sul supporto della pedana.

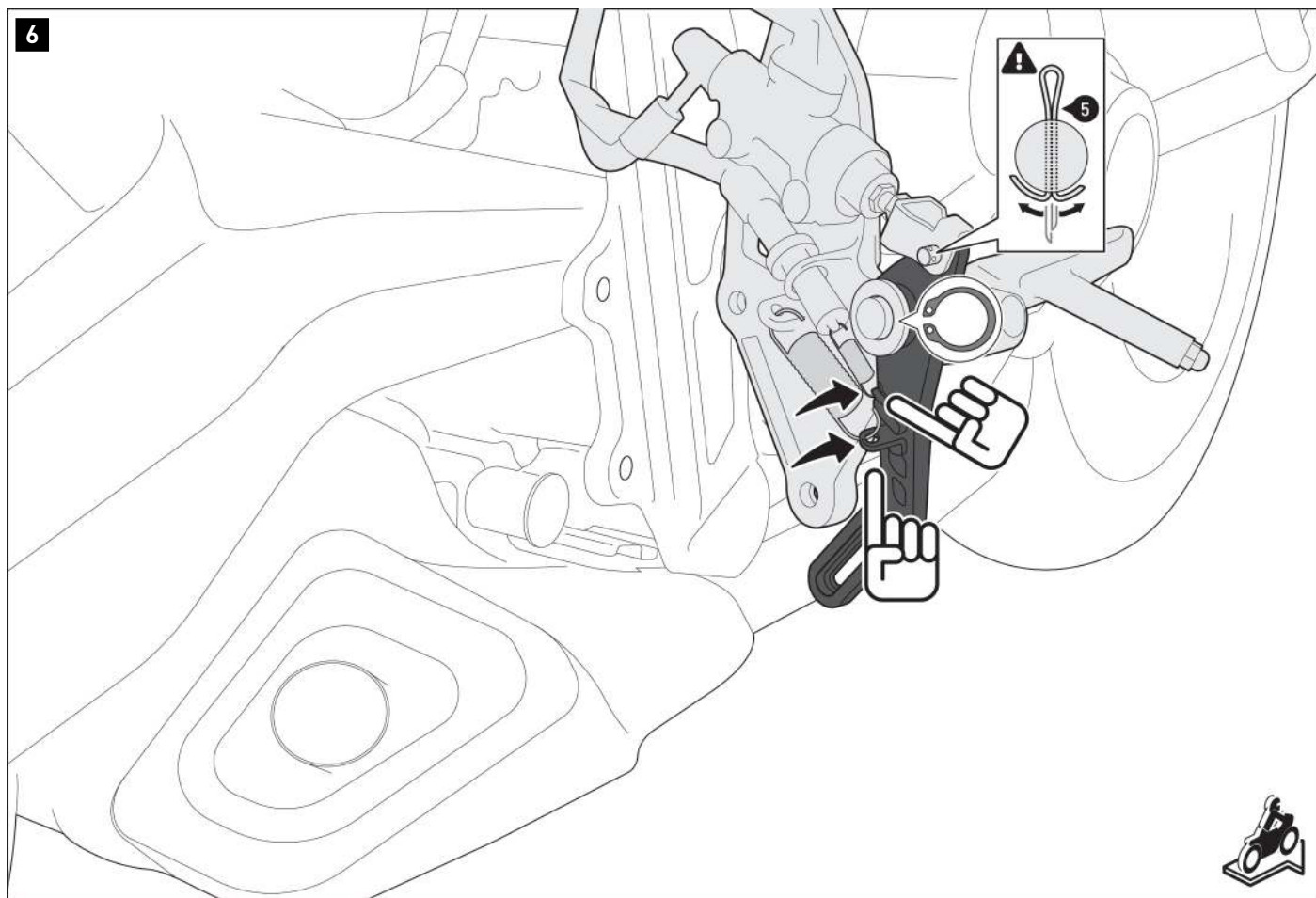

Appendere le molle nella posizione indicata.
Montare l'asta di pressione originale (Orig.) collegandola alla **nuova** coppia di sicurezza [5].
Installare l'anello di bloccaggio originale.



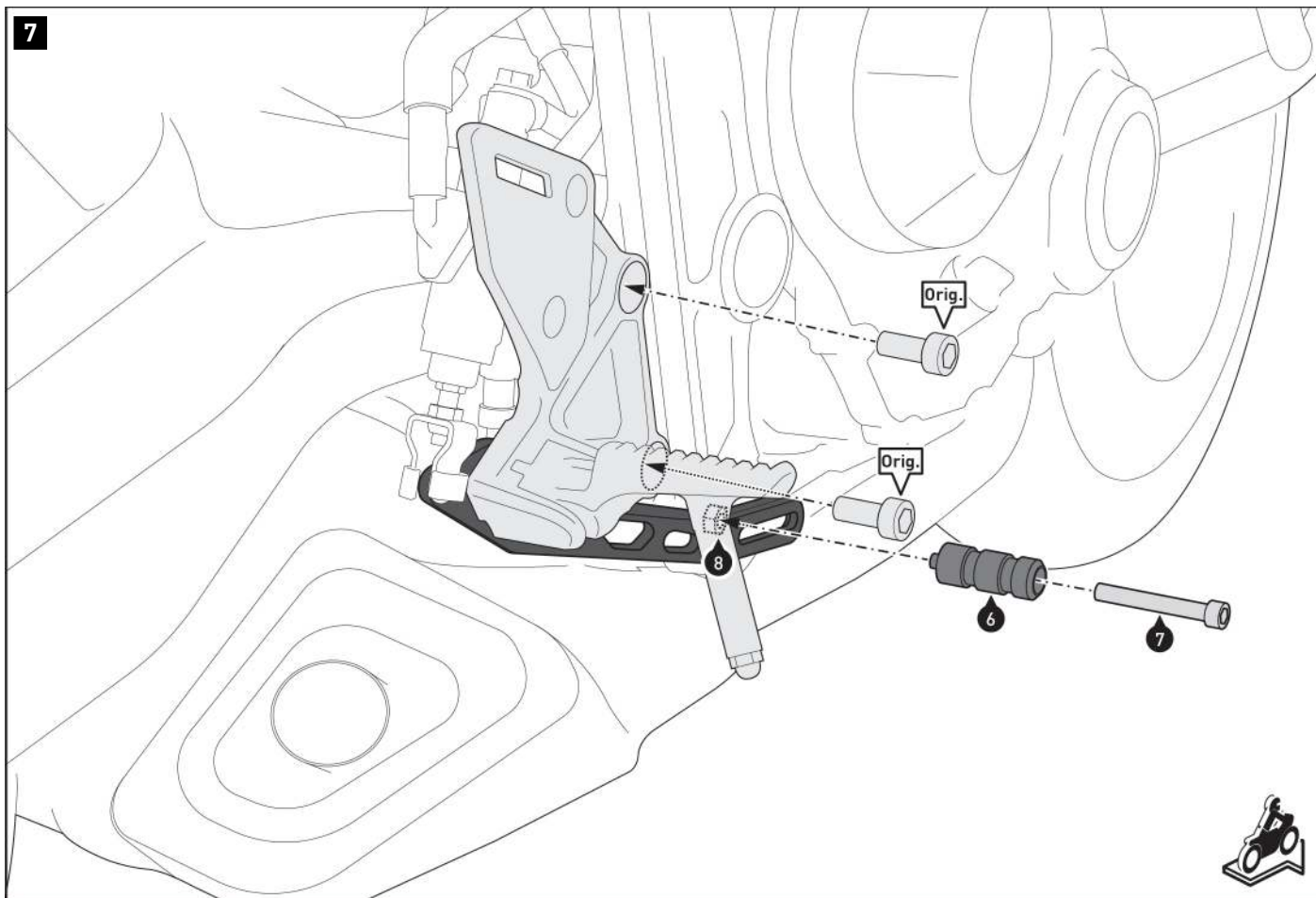

Avvitare il pedale (6) alla leva del freno
Non serrare ancora la vite (7).

Avvitare il supporto della pedana al veicolo utilizzando le viti originali (Orig.).
⚠ ATTENZIONE: utilizzare un frenafretili liquido! (solo (Orig.))
Avvitare le viti originali (Orig.) secondo le istruzioni del produttore.

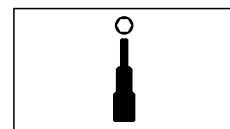
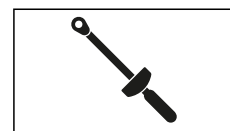

8

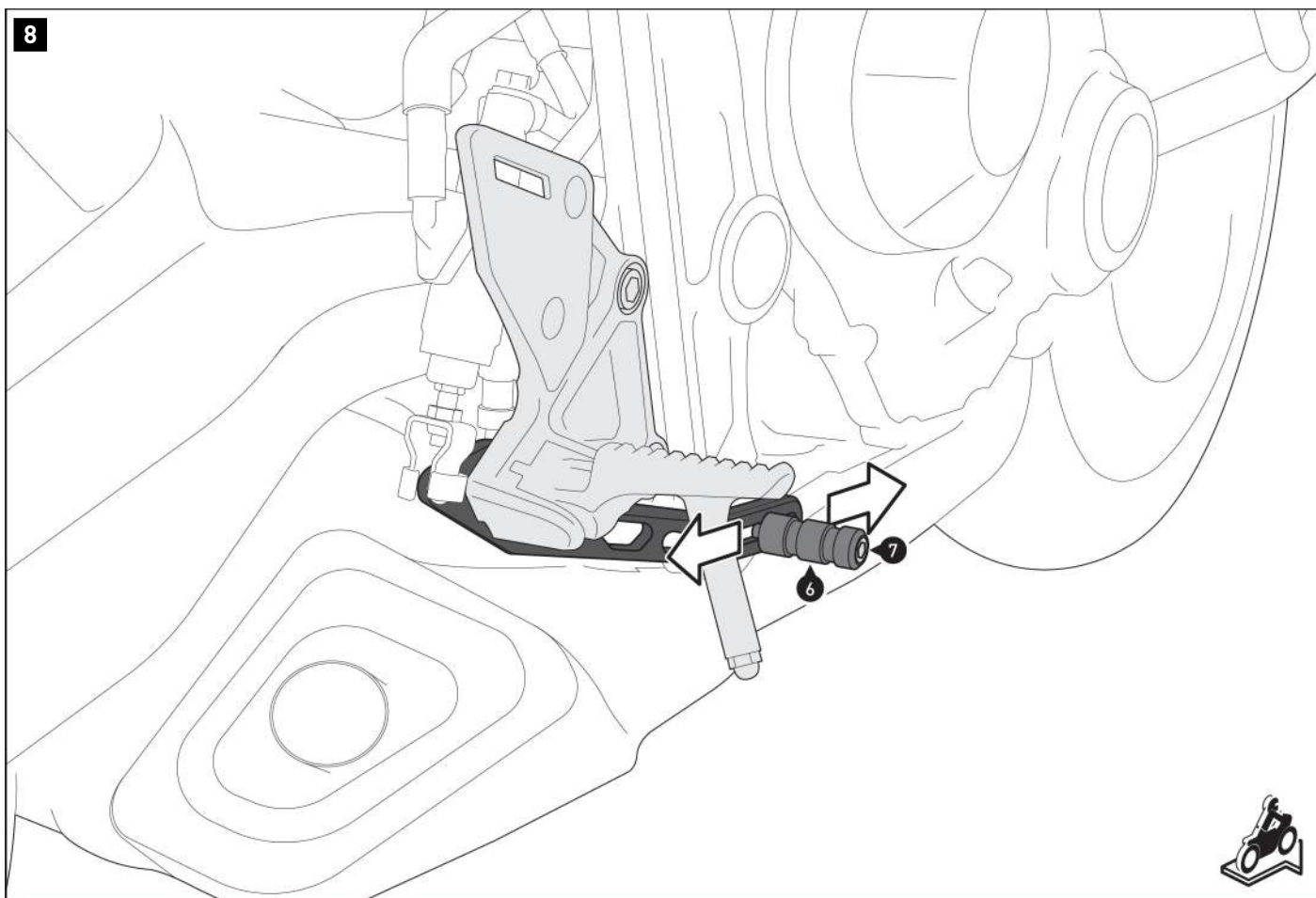

Regolare il pedale (6) in base alle proprie abitudini di guida.
Quindi serrare la vite (7) come specificato nelle istruzioni per il montaggio.

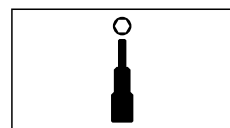
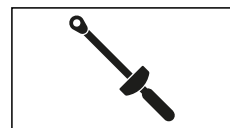

AVVERTENZE SPECIFICHE DEL PRODOTTO

▲ PERICOLO: alla fine fate eseguire un controllo funzionale completo dell'impianto frenante del vostro veicolo da un'officina specializzata qualificata e certificata!

▲ AVVERTENZA: in caso di inclinazione estrema, questo prodotto può limitare la tenuta in curva e in marcia su rettilineo!

▲ AVVISO: Osservare le normative specifiche del paese per l'immatricolazione/il funzionamento del veicolo o le normative TÜV applicabili. Dopo l'installazione, le parti soggette a omologazione devono essere registrate nei documenti del veicolo dall'autorità di controllo.

Se è disponibile un certificato di omologazione nazionale (ABE) per questo prodotto:

L'ABE consegnato con il prodotto deve viaggiare sempre con il veicolo!

Questo ABE si applica solo ai modelli elencati e conformi a tutti i requisiti!

Per l'uso sul veicolo non elencato qui, l'iscrizione deve essere fatta nei documenti del veicolo!

Le assegnazioni dei veicoli nel certificato ABE vengono ampliate ogni anno. Di conseguenza l'ABE per un nuovo prodotto può essere rilasciato anche a distanza di diversi mesi dal lancio sul mercato. Se il tuo modello non è elencato o se non hai più il certificato ABE, visita la sezione download del nostro negozio online. La versione attuale del documento ABE è in quella sezione.

Art.-Nr.: FSC.01.529.10000

Revision: 00 · Datum: 06 - 2023

Schalthebel

 ~ 0.75 h.LEICHT     SCHWER

DEUTSCH - Vielen Dank, dass Sie sich für dieses Premium-Produkt von SW-MOTECH entschieden haben. Besuchen Sie unseren Webshop für weitere Informationen (z. B. Modellzuweisungen). Erforderliche Dokumente (z. B. ABE) stehen Ihnen dort als Download zur Verfügung.

Bitte lesen und verstehen Sie alle Anweisungen, Sicherheitshinweise und Warnungen in dieser Anbauanleitung vor Montage und Nutzung des Produkts, um Verletzungen und Schäden zu vermeiden. Bewahren Sie diese Anbauanleitung als Referenz auf.

Dieses Produkt wurde für Fahrzeuge im Werkzustand entwickelt. Die Kompatibilität mit Original-Zubehörteilen bzw. den Zubehörteilen anderer Hersteller kann nicht gewährleistet werden.

Diese Anbauanleitung ist nach unserem derzeitigen Kenntnisstand verfasst worden. Rechtliche Ansprüche auf Richtigkeit bestehen nicht. Fehler und Irrtümer vorbehalten. Technische und gestalterische Änderungen sind vorbehalten. Das Urheberrecht liegt bei SW-MOTECH.

SICHERHEITSWARNUNGSSYMBOL

 Dieses Warnsymbol wird in dieser Anbauanleitung verwendet, um vor tödlichen Gefahren, Verletzungen oder anderen Gefahren zu warnen. Die Wörter **GEFAHR**, **WARNUNG** oder **VORSICHT** werden mit diesem Warnsymbol verwendet, um wichtige Sicherheitshinweise und Informationen in Bezug auf die Montage und Nutzung dieses Produkts zu übermitteln. Diese Wörter zusammen mit dem Sicherheitswarnsymbol bedeuten:

▲ GEFAHR: Weist auf eine gefährliche Situation hin, die zum Tod oder zu schweren Verletzungen führt, wenn sie nicht vermieden wird!

▲ WARNUNG: Weist auf eine gefährliche Situation hin, die zum Tod oder zu schweren Verletzungen führen kann, wenn sie nicht vermieden wird!

▲ VORSICHT: Weist auf eine gefährliche Situation hin, die zu leichten oder mittelschweren Verletzungen führen kann, wenn sie nicht vermieden wird!

▲ HINWEIS: Wichtige Informationen, jedoch nicht in Bezug auf Todes- oder Verletzungsgefahr (nur Sachschäden)!

ALLGEMEINE HINWEISE

▲ WARNUNG: Die Montage und/oder Wartung dieses Produkts erfordert fortgeschrittene technische Fähigkeiten, geeignetes Werkzeug und ein gutes Verständnis der Werkzeugnutzung und Drehmomentangaben. Zu Ihrer eigenen Sicherheit empfiehlt SW-MOTECH, die Montage und/oder Wartung von einer qualifizierten und zertifizierten Zweiradwerkstatt durchführen zu lassen.

▲ WARNUNG: Wenn Sie sich für die Eigenmontage dieses Produkts entscheiden, lesen Sie vor Montage und Nutzung die Anbauanleitung sorgfältig und vollständig durch und befolgen Sie alle Anweisungen, um schwere oder tödliche Verletzungen zu vermeiden. Beachten Sie bei der Montage und Verwendung auch alle relevanten Informationen im Fahrzeughandbuch. **WENN SIE EINEN TEIL DIESER ANBAUANLEITUNG NICHT VERSTEHEN ODER EINE ERKLÄRUNG EINER ANWEISUNG BENÖTIGEN, VERSUCHEN SIE NICHT DIESES PRODUKT ZU MONTIEREN, OHNE SW-MOTECH UM HILFE ZU FRAGEN!**

VORBEREITUNG: Lesen Sie die Anbauanleitung aufmerksam und stellen Sie sicher, dass alle Teile der Stückliste vorhanden sind.

▲ VORSICHT: Achten Sie auf den sicheren Stand Ihres Fahrzeugs. Schalten Sie den Motor ab und ziehen Sie den Zündschlüssel. Lassen Sie den Motor/Auspuff bei Bedarf abkühlen. Klemmen Sie die Batterie bei Arbeiten an der Elektrik ab. Verwenden Sie nur geeignetes Werkzeug und tragen Sie während der Montage und Wartung immer eine Schutzbrille und Handschuhe. Lassen Sie sich bei der Montage und Wartung von einer zweiten Person helfen.

MONTAGE: Alle vom Fahrzeug entfernten Teile und Verbindungen müssen gemäß den Angaben des Fahrzeugherstellers wieder eingebaut oder durch von SW-MOTECH gelieferte Teile und Hardware ersetzt werden.

▲ WARNUNG: Sichern Sie alle Gewinde, sofern nicht anders angegeben, mit mittelstarker, flüssiger Schraubensicherung.

▲ GEFAHR: Von SW-MOTECH nicht definierte Anzugsdrehmomente müssen Sie vom Fahrzeughersteller oder von einer zertifizierten Motorradwerkstatt beziehen.

FUNKTIONSKONTROLLE: Stellen Sie nach der Montage sicher, dass keine beweglichen Teile blockiert sind und die Funktion des Fahrzeugs nicht gestört wird. Kabel und Schläuche dürfen nicht scheuern und/oder geklemmt werden.

▲ WARNUNG: Führen Sie vor Fahrtbeginn eine umfassende Funktionskontrolle durch. Prüfen Sie nach den ersten 50 km und dann regelmäßig das Anzugsmoment aller Verbindungen und den festen Sitz des Produkts. Montiertes Zubehör kann das Fahrverhalten und die Stabilität des Fahrzeugs verändern.



SW-MOTECH GmbH & Co. KG
Ernteweg 7-10
35282 Rauschenberg
Deutschland



info@sw-motech.com
www.sw-motech.com



Beachten Sie in dem Abschnitt MONTAGE vorkommenden Symbole und deren Bedeutung. Wenn im Abschnitt MONTAGE die Bezeichnung OEM vorkommt, müssten die Vorgaben des Fahrzeugherstellers beachtet und angewandt werden.



Bei Fragen steht Ihnen unser Kundendienst sowie unsere Distributoren gerne zur Verfügung. Unsere Telefonnummer sowie eine Liste unserer Distributoren finden Sie in unserem Webshop: www.sw-motech.com



Schraubensicherung verwenden: Weist darauf hin, dass ein Gewinde mit flüssiger Schraubensicherung bestrichen werden muss. H (HIGH): hohe Festigkeit; M (MEDIUM): mittlere Festigkeit; L (LOW): niedrige Festigkeit.



Anziehen / Anzugsmomentangabe beachten: Weist auf das von SW-MOTECH bzw. vom Fahrzeughersteller (OEM) vorgegebene Anzugsmoment eines Teils hin.

STÜCKLISTE - ANBAUANLEITUNG LESEN UND AUFBEWAHREN!

2

1



FSC.01.529.900.01.02

 1/1

2



FSC.00.127.700

 1/1

3



M6 x 16; DIN 7991
SC.ST.06.016.01.7991.088

 1/1

4



M6; DIN 985
MU.ST.06.01.985.08

 1/1

5



KTM.54603069000

 1/1

6



M6 x 20; ISO 7380
SC.ST.06.020.01.73800.109

 1/1

7



Ø 12 / ø 6,4 / h 3
DB.00.120.064.003.01

 1/1

4

8



FSC.00.127.011.36

 1/1

9



M6 x 25; DIN 912
SC.ST.06.025.01.912.088

 1/1

10



FSC.00.127.022.02

 1/1

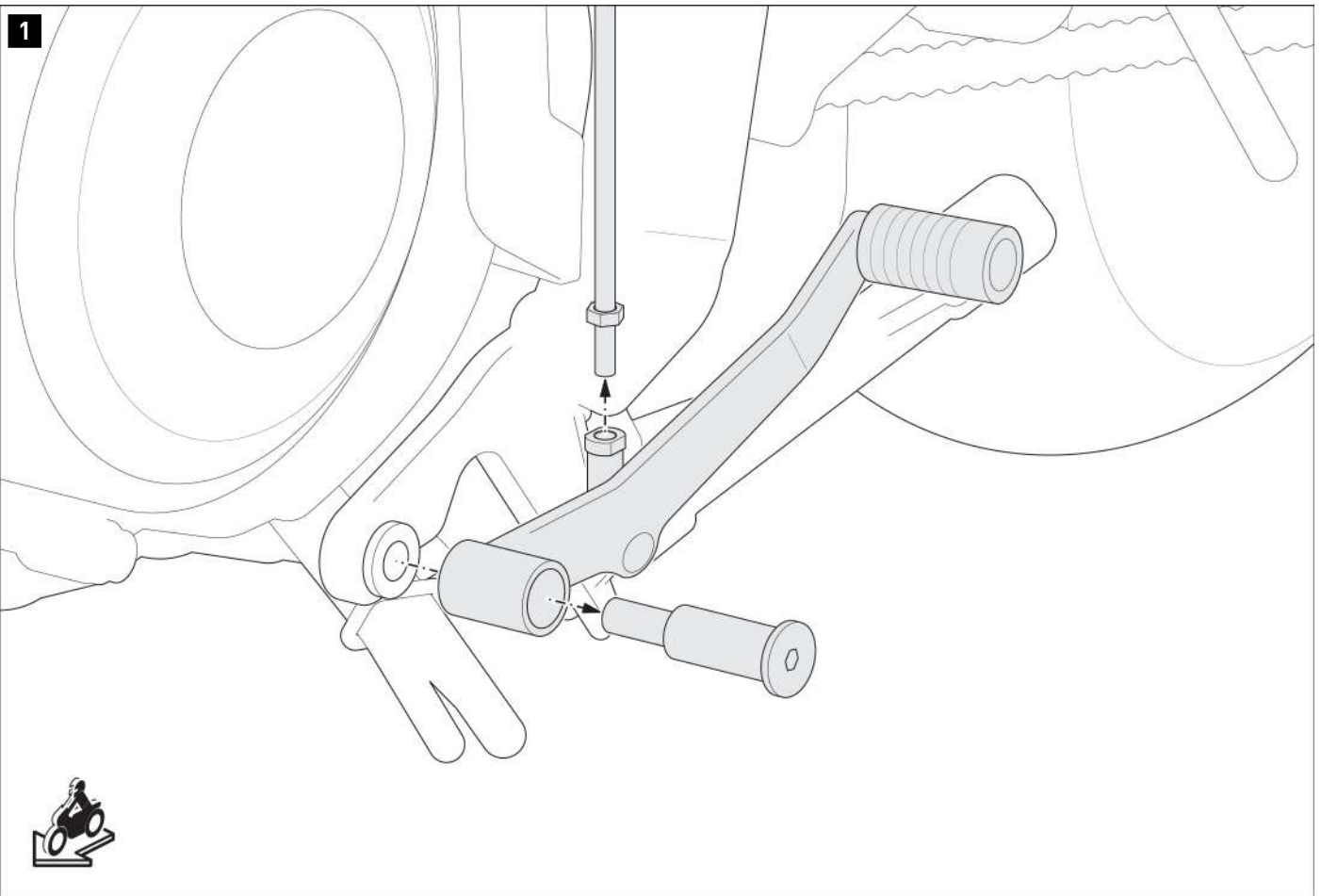

- ▲ **WARNUNG: Tragen Sie immer Augen- und Handschutz!**
- ▲ **WARNUNG: Verwenden Sie immer geeignetes Werkzeug!**

Lösen Sie die gezeigten Teile; entfernen Sie den original Schalthebel vom Fahrzeug.

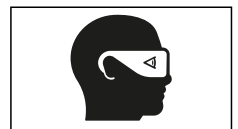

2

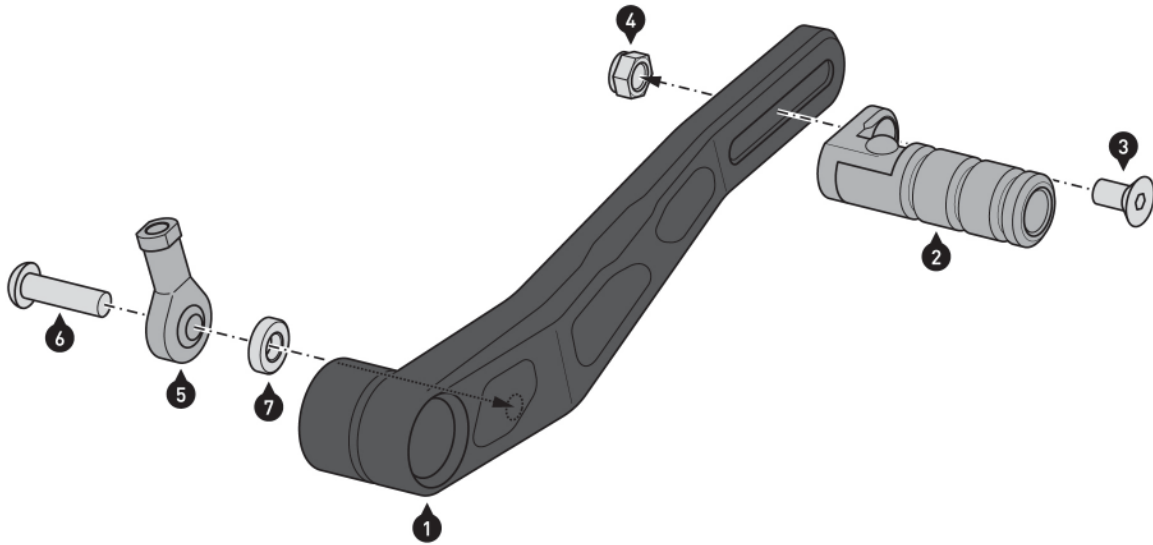

⚠ HINWEIS: Die Montage der optionalen Anbauteile (8) – (10) wird in Schritt [4] beschrieben.

Verschrauben Sie die gezeigten Teile am Schalthebel (1).

⚠ WARNUNG: Verwenden Sie flüssige Schraubensicherung (nur Schraube (6))!

Ziehen Sie die Schraube (6) wie in der Anbauanleitung vorgegeben an.
Ziehen Sie die Schraube (3) noch nicht an.

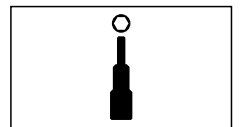
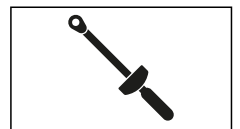

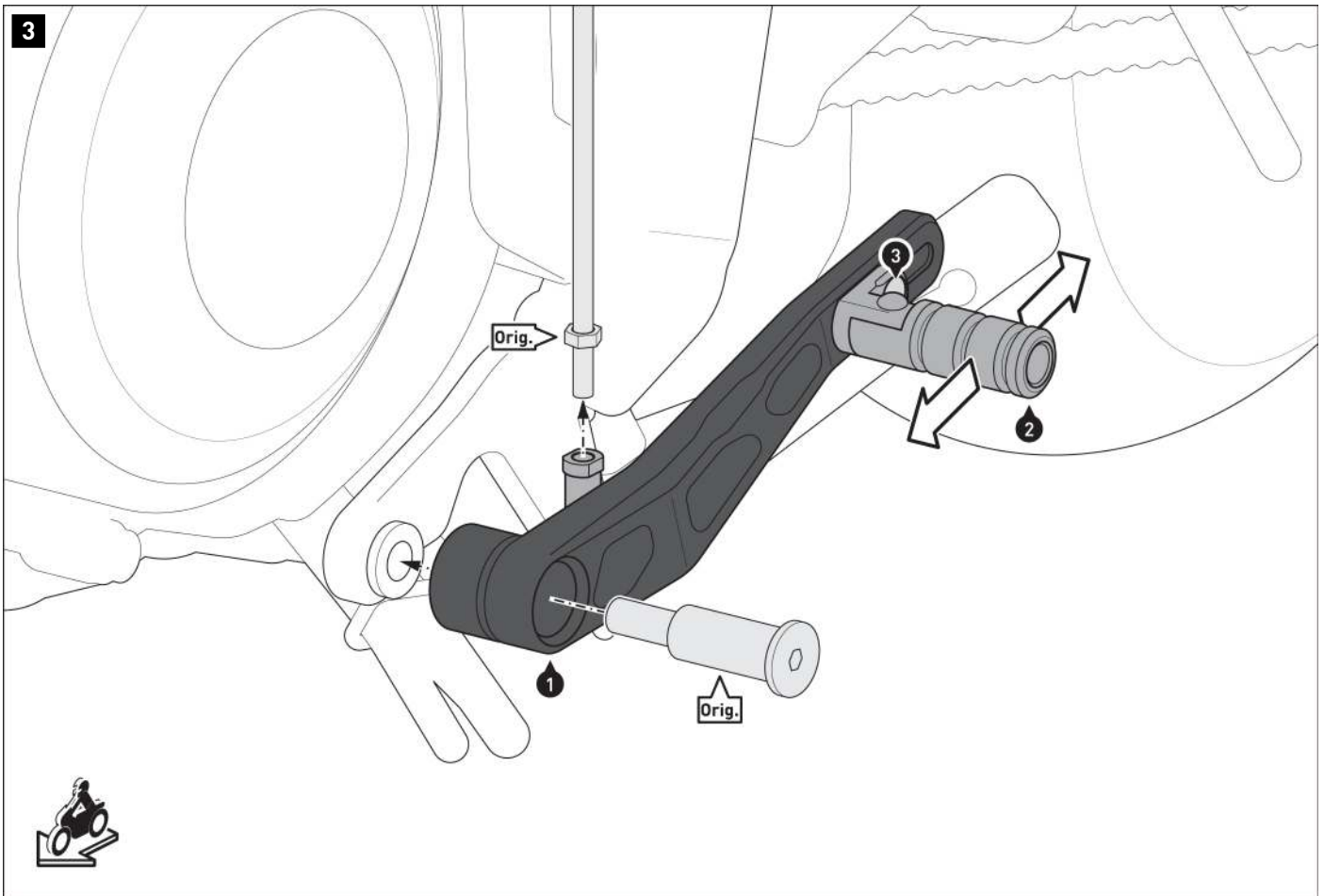

Verschrauben Sie die original Umlenkstange (Orig.) mit dem Schalthebel (1) (min. 6 Gewindegänge); kontern Sie das Gewinde mit der Mutter.

Verschrauben Sie den Schalthebel (1) mit der original Schraube (Orig.) am Fahrzeug.

⚠ WARNUNG: Verwenden Sie flüssige Schraubensicherung!
Ziehen Sie die original Schraube (Orig.) nach Herstellerangaben an.

Stellen Sie den Auftritt (2) entsprechend Ihrer Fahrgewohnheiten ein.
Ziehen Sie anschließend die Schraube (3) wie in der Anbauanleitung vorgegeben an.

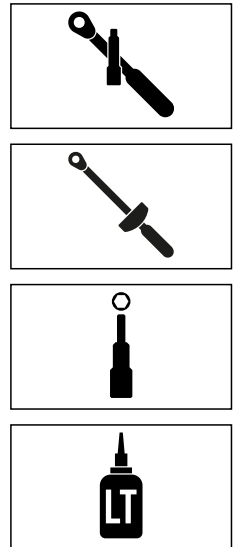

4

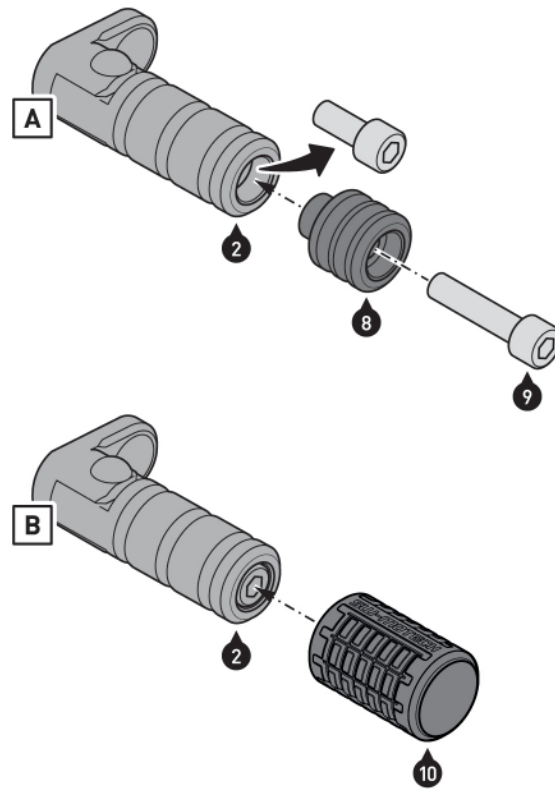

⚠ HINWEIS: Dieser Montageschritt ist optional.

Option [A]: Entfernen Sie die im Auftritt (2) vormontierte Schraube. Verschrauben Sie die Auftritt-Verlängerung (8) mit dem Auftritt (2).

⚠ WARNUNG: Verwenden Sie flüssige Schraubensicherung!

Ziehen Sie die Schraube (9) wie in der Anbauanleitung vorgegeben an.

Option [B]: Stülpen Sie die Gummihülse (10) über den Auftritt (2).

Achten Sie darauf, dass die innenliegenden Ringe der Gummihülse (10) in den Vertiefungen des Auftritts (2) sitzen.

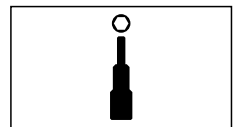
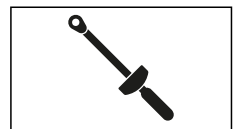

PRODUKTSPEZIFISCHE HINWEISE

▲ WARNUNG: Die Kurven- und Bodenfreiheit kann bei extremer Schräglage durch dieses Produkt eingeschränkt werden!

▲ WARNUNG: Stellen Sie nach Montage des Schalthebels sicher, dass die Freigängigkeit aller Komponenten im Montagebereich gewährleistet ist! Schalten Sie alle Gänge durch und stellen Sie sicher, dass die Justierung des Schalthebels Ihrer Fahrergonomie entspricht!

▲ HINWEIS: Beachten Sie die landesspezifischen Vorschriften für Zulassung/Betrieb Ihres Fahrzeugs bzw. anwendbare TÜV-Vorschriften. Lassen Sie eintragungspflichtige Teile nach Montage durch Ihre Prüfstelle in die Fahrzeugpapiere eintragen.

Item number: **FSC.01.529.10000**

Revision: **00** · Date: **06 - 2023**

Gear lever

 ~ 0.75 h.

EASY     DIFFICULT

ENGLISH Thank you for choosing this premium product from SW-MOTECH. Visit our online shop for more information (e.g. model assignments). Required documents (e.g. national type approval) are available there for you to download.

Please read and understand all the instructions, safety information and warnings in these mounting instructions before mounting and using the product in order to avoid injury and damage. Keep these mounting instructions for reference.

This product was developed for vehicles in factory condition. Compatibility with original accessories or accessories from other manufacturers cannot be guaranteed.

These mounting instructions have been prepared to the best of our current knowledge. No legal claims relating to accuracy can be made. Errors and omissions excepted. We reserve the right to make technical and design changes. The copyright is held by SW-MOTECH.

SAFETY WARNING SYMBOL

 This warning symbol is used in these mounting instructions to warn of deadly dangers, injuries or other hazards. The words **DANGER, WARNING or CAUTION** are used as part of this warning symbol to convey important safety messages and information relating to the installation and use of this product. These words, together with the safety warning symbol, mean:

 **DANGER:** Indicates a hazardous situation which, if not avoided, will result in death or serious injury!

 **WARNING:** Indicates a hazardous situation which, if not avoided, may result in death or serious injury!

 **CAUTION:** Indicates a hazardous situation which, if not avoided, may result in minor or moderate injury!

 **NOTE:** Important information, but not relating to a risk of death or injury (property damage only)!

GENERAL INFORMATION

 **WARNING:** Assembly and/or maintenance of this product requires advanced technical skill, appropriate tools, and a good understanding of tool usage and torque specifications. For your own safety, SW-MOTECH recommends having the assembly and/or maintenance carried out by a qualified and certified motorcycle workshop.

 **WARNING:** If you do choose to assemble this product yourself, carefully and fully read the mounting instructions before assembly and use, and follow all instructions to avoid serious injury or death. Also observe all relevant information in the vehicle manual when mounting or using the product. **IF YOU DO NOT UNDERSTAND ANY PART OF THESE MOUNTING INSTRUCTIONS OR NEED AN EXPLANATION AS TO A SPECIFIC INSTRUCTION, DO NOT ATTEMPT TO INSTALL THIS PRODUCT WITHOUT CONSULTING SW-MOTECH FOR ASSISTANCE!**

PREPARATION: Read the mounting instructions carefully and make sure that all parts on the parts list are available.

 **CAUTION:** Ensure that your vehicle is standing securely. Switch off the engine and remove the ignition key. Allow the engine/exhaust to cool down if necessary. Disconnect the battery when working on the electrical system. Only use proper tools and always wear safety goggles and gloves during assembly and maintenance. Have a second person help you with assembly and maintenance.

ASSEMBLY: All parts and connections removed from the vehicle must be reinstalled according to the vehicle manufacturer's specifications or replaced with parts and hardware supplied by SW-MOTECH.

 **WARNING:** Secure all threads with a medium-strength liquid threadlocker, unless otherwise specified.

 **DANGER:** Tightening torques not defined by SW-MOTECH must be obtained from the vehicle manufacturer or a certified motorbike workshop.



FUNCTIONAL CHECK: After mounting the product, ensure that no moving parts are obstructed and that the function of the vehicle is not impeded. Cables and hoses must not rub against each other and/or be hindered in any way.

 **WARNING:** Carry out a comprehensive functionality check before you start to drive. Check the tightening torque of all connections and the tight fit of the product after the first 50 km and then at regular intervals. Mounted accessories can change the handling and stability of the vehicle.



SW-MOTECH GmbH & Co. KG
Ernteweg 7-10
35282 Rauschenberg
Germany



 info@sw-motech.com
 www.sw-motech.com



Take note of the symbols and what they mean in the ASSEMBLY section. If the term OEM appears in the ASSEMBLY section, the vehicle manufacturer's specifications must be observed and applied.



If you have any questions, please don't hesitate to contact our Customer Service team or our distributors. You can find our telephone number and a list of our distributors in our online shop:

www.sw-motech.com























Use thread locker: Indicates that a thread must be coated with liquid thread locker. H (HIGH): high strength; M (MEDIUM): medium strength; L (LOW): low strength.



Tighten/note the tightening torque information:

Indicates the tightening torque of a part specified by SW-MOTECH or the vehicle manufacturer (OEM).

PARTS LIST - READ AND KEEP MOUNTING INSTRUCTIONS!

<p>2</p>	<p>1</p> 	<p>2</p> 	<p>3</p> 	<p>4</p> 	<p>5</p> 	<p>6</p> 
	<p>FSC.01.529.900.01.02</p> <p> 1/1</p>	<p>FSC.00.127.700</p> <p> 1/1</p>	<p>M6 x 16; DIN 7991 SC.ST.06.016.01.7991.088</p> <p> 1/1</p>	<p>M6; DIN 985 MU.ST.06.01.985.08</p> <p> 1/1</p>	<p>KTM.54603069000</p> <p> 1/1</p>	<p>M6 x 20; ISO 7380 SC.ST.06.020.01.73800.109</p> <p> 1/1</p>
	<p>7</p> 					
	<p>Ø 12 / ø 6,4 / h 3 DB.00.120.064.003.01</p> <p> 1/1</p>					
<p>4</p>	<p>8</p> 	<p>9</p> 	<p>10</p> 			
	<p>FSC.00.127.011.36</p> <p> 1/1</p>	<p>M6 x 25; DIN 912 SC.ST.06.025.01.912.088</p> <p> 1/1</p>	<p>FSC.00.127.022.02</p> <p> 1/1</p>			

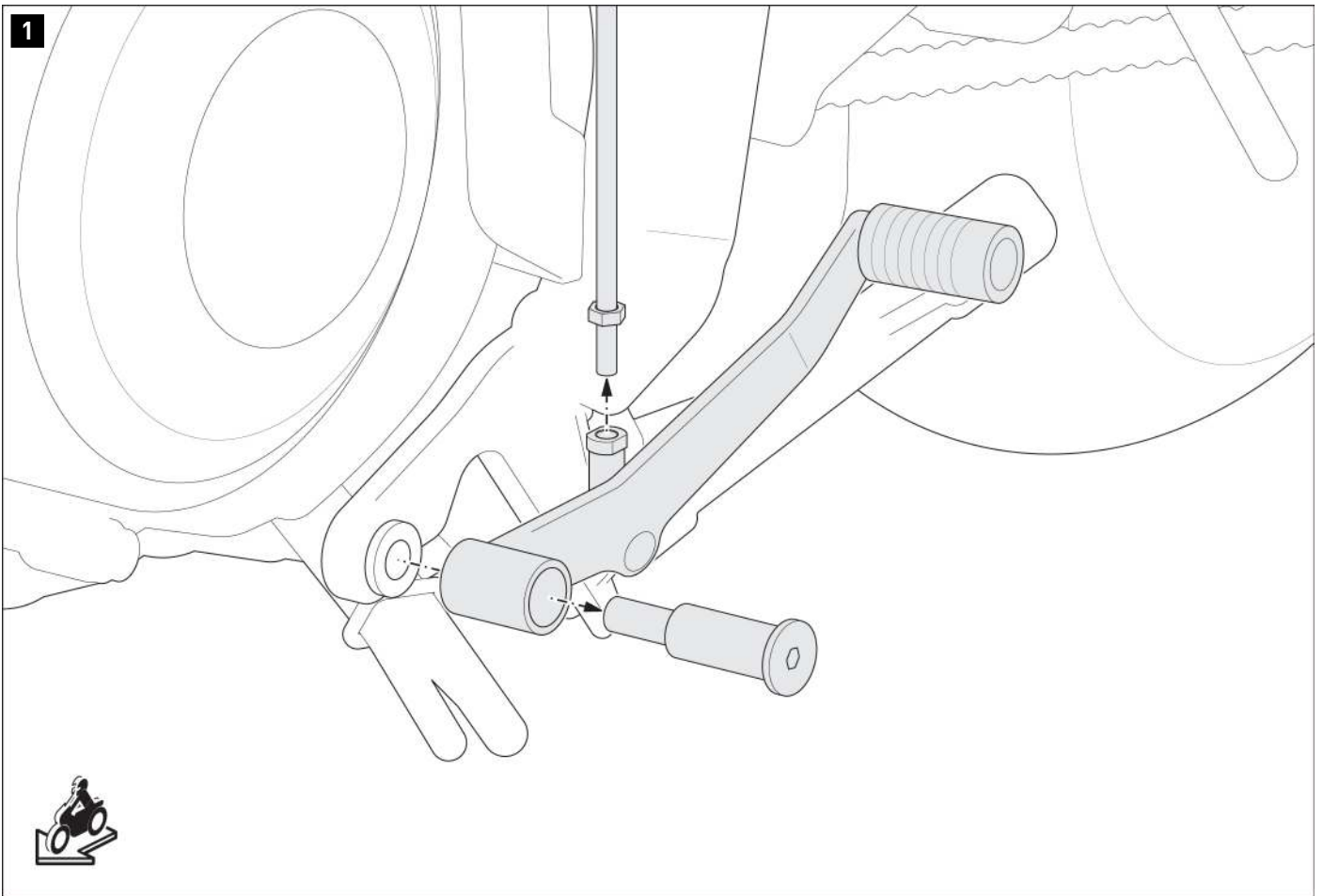

- ▲ **WARNING: Always wear eye and hand protection!**
- ▲ **WARNING: Always use the proper tools!**

Loosen the parts shown; remove the original gear lever from the vehicle.



2

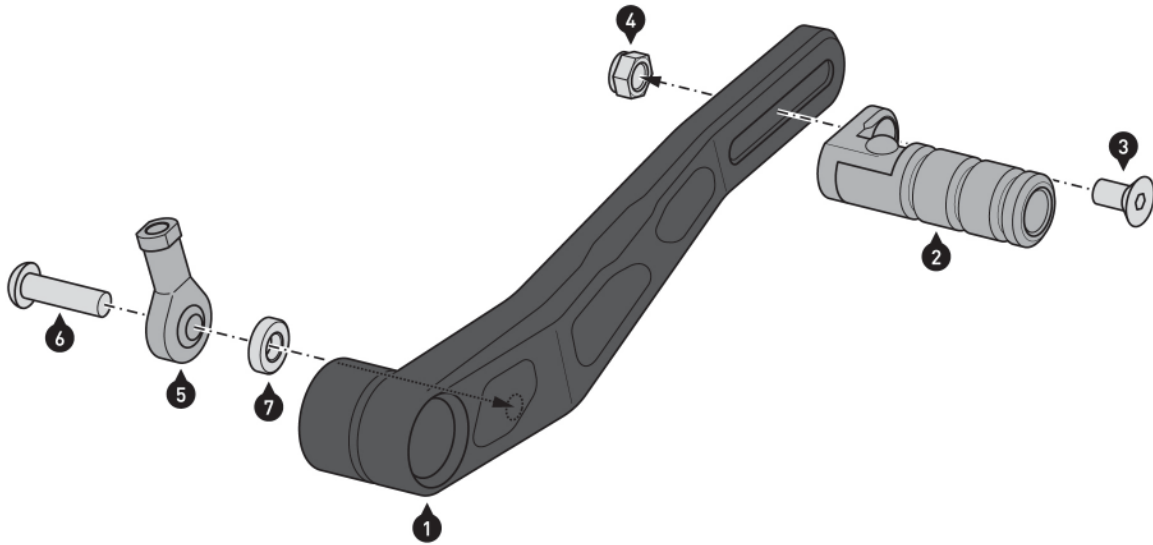

NOTE: How to mount optional add-on parts (8) - (10) is described in step [4].

Screw the parts shown to the gear lever (1).

WARNING: Use liquid thread locker (only for screw (6))!
Tighten the screw (6) as specified in the mounting instructions.
Do not tighten the screw (3) yet.

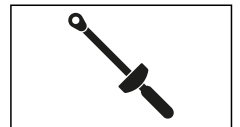

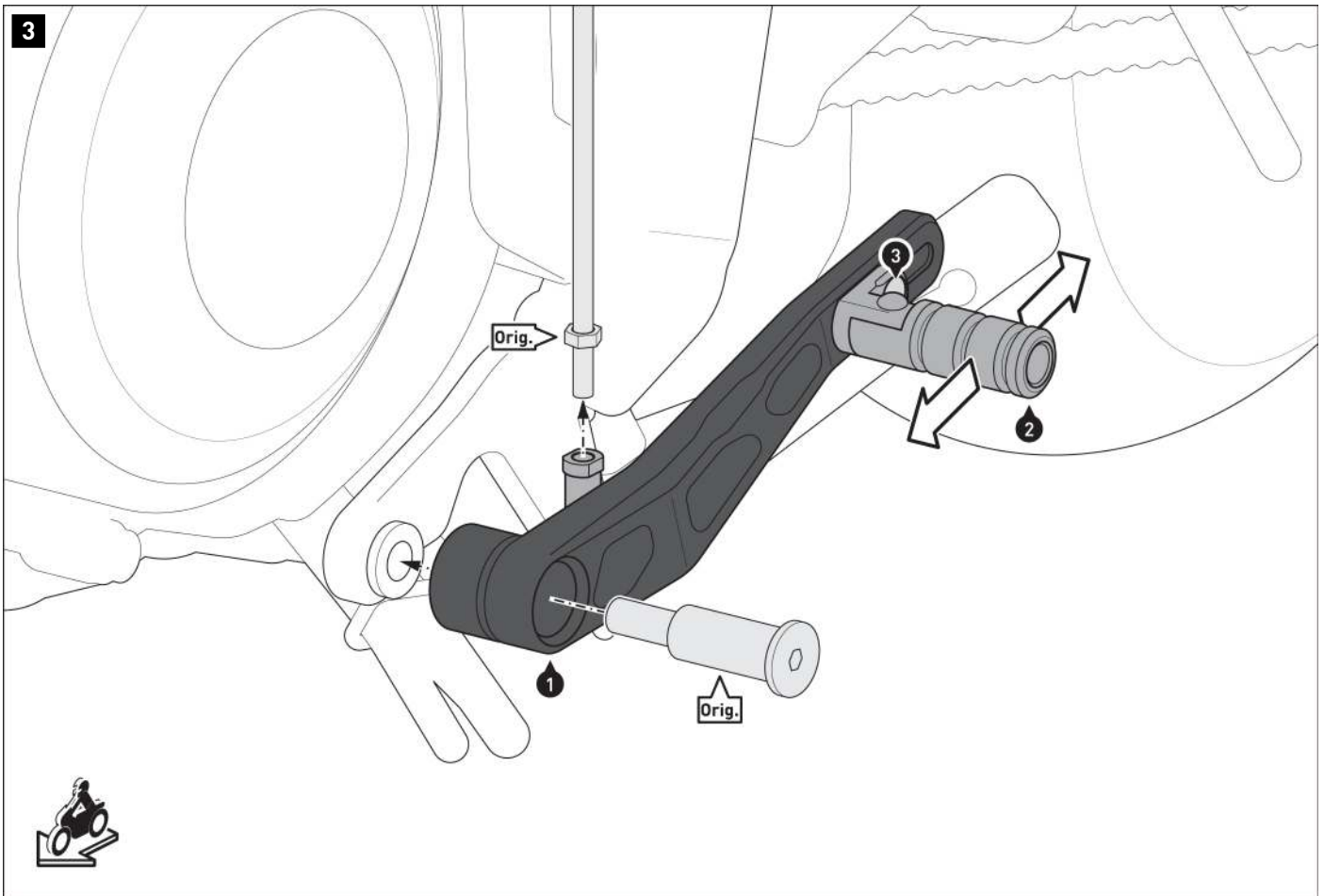

Screw the original deflection rod (orig.) to the gear lever (1) (min. 6 thread); counter the thread with a nut.

Screw the gear lever (1) onto the vehicle using the original screw (orig.).

▲ WARNING: Use a liquid threadlocker!

Tighten the original screw (Orig.) according to the manufacturer's instructions.

Adjust the tread (2) according to your driving habits.

Then tighten the screw (3) as specified in the mounting instructions.

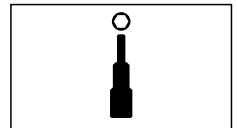
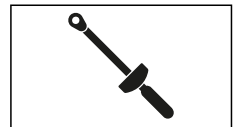

4

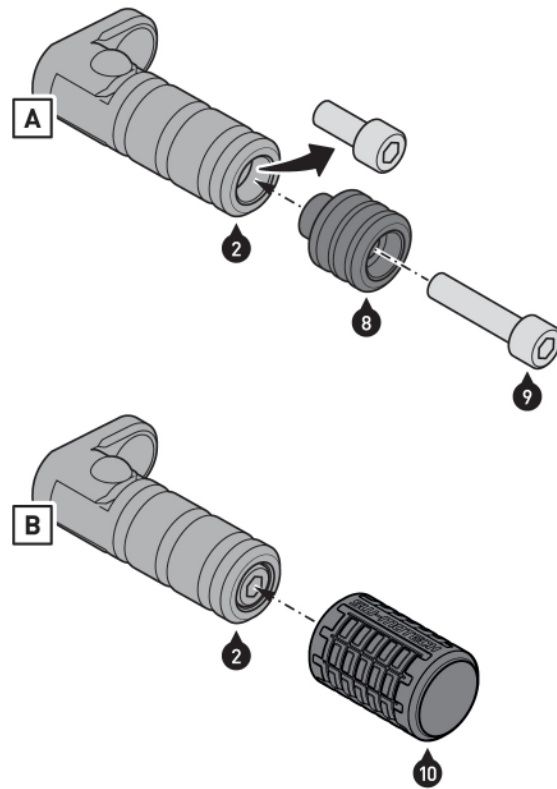

NOTE: This step is optional.

Option [A]: Remove the factory-installed screw from the pedal (2).
Screw the pedal extension (8) to the pedal (2).

WARNING: Use a liquid threadlocker!

Tighten the screw (9) as specified in the mounting instructions.

Option [B]: Pull the rubber sleeve (10) over the pedal (2).

Ensure that the inner rings of the rubber sleeve (10) are positioned in the recesses of the pedal (2).

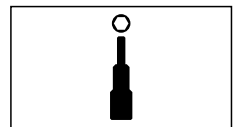
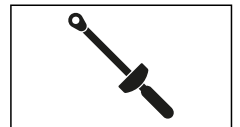

PRODUCT-SPECIFIC NOTES

⚠ WARNING: The cornering and ground clearance may be restricted by this product in the case of extreme inclination!

⚠ WARNING: After installing the gear lever, ensure that all components in the area are not in any way restricted in movement! Shift through all the gears and make sure that the position of the gear lever suits your driver's needs!

⚠ NOTE: Observe the country-specific regulations for the registration/operation of your vehicle or any applicable TÜV regulations. Have parts subject to registration entered in the vehicle documents by your inspection authority after installation.

Número de artículo: FSC.01.529.10000

Revisión: 00 · Fecha: 06 - 2023

Palanca de cambio

 ~ 0.75 h.

 FÁCIL     COMPLICADO

ESPAÑOL · Gracias por elegir este producto de primera calidad de SW-MOTECH. Visite nuestra tienda online para obtener más información (p. ej., sobre el uso de los modelos). Desde esa página podrá descargar los documentos que necesite (por ejemplo, la homologación nacional de tipo).

Para evitar lesiones y daños, asegúrese de leer y comprender todas las instrucciones, advertencias de seguridad y precauciones de este manual antes de montar y utilizar el producto. Guarde estas instrucciones de montaje como referencia.

Este producto ha sido desarrollado para vehículos en condiciones de fábrica. No se garantiza la compatibilidad con los accesorios originales o de otros fabricantes.

Estas instrucciones de montaje se han redactado de acuerdo con nuestros conocimientos actuales. No hay reclamaciones legales de corrección. Salvo errores y omisiones. Nos reservamos el derecho a realizar cambios técnicos y de diseño. Los derechos de autor pertenecen a SW-MOTECH.

SÍMBOLO DE ADVERTENCIA DE SEGURIDAD

 Este símbolo de advertencia se utiliza en estas instrucciones de montaje para advertir de peligros mortales, lesiones u otros riesgos. Las palabras PELIGRO, ATENCIÓN o PRECAUCIÓN se utilizan con este símbolo de advertencia para transmitir importantes avisos de seguridad e información relacionada con el montaje y uso de este producto. Estas palabras, junto con el símbolo de advertencia de seguridad, significan:

 **PELIGRO:** Indica una situación de peligro que, si no se evita, provoca lesiones graves o incluso la muerte.

 **ATENCIÓN:** Indica una situación de peligro que, si no se evita, puede provocar lesiones graves o incluso la muerte.

 **PRECAUCIÓN:** Indica una situación de peligro que, si no se evita, puede provocar lesiones leves o de gravedad media.

 **NOTA:** Información importante, pero que no está relacionada con un riesgo de lesiones o muerte (solo daños materiales).

INDICACIONES GENERALES

 **ATENCIÓN:** El montaje y/o mantenimiento de este producto requiere conocimientos técnicos avanzados, las herramientas apropiadas, un buen manejo de dichas herramientas y conocer las especificaciones de los pares de apriete. Por su propia seguridad, SW-MOTECH recomienda que el montaje y/o el mantenimiento los realice un taller de motocicletas cualificado y certificado.

 **ATENCIÓN:** Si elige ensamblar este producto usted mismo, antes de montarlo y usarlo, lea las instrucciones de montaje detenidamente y en su totalidad, y siga todas las indicaciones para evitar lesiones graves o mortales. Cuando monte y utilice el producto, tenga también en cuenta toda la información relevante que figure en el manual del vehículo. SI NO ENTIENDE ALGUNA PARTE DE ESTAS INSTRUCCIONES DE MONTAJE O NECESITA ALGUNA ACLARACIÓN, NO INTENTE INSTALAR ESTE PRODUCTO SIN CONSULTAR A SW-MOTECH PARA OBTENER AYUDA.

PREPARACIÓN: Lea atentamente las instrucciones de montaje y asegúrese de que todas las piezas de la lista de piezas están presentes.

 **PRECAUCIÓN:** Asegúrese de que su vehículo esté estacionado de manera segura. Apague el motor y retire la llave de encendido. Deje que el motor o el escape se enfrien si es necesario. Desconecte la batería cuando trabaje en el sistema eléctrico. Utilice únicamente las herramientas adecuadas y use siempre gafas de seguridad y guantes al realizar el montaje y las tareas de mantenimiento. Pida a otra persona que le ayude con el montaje y el mantenimiento.

MONTAJE: Todas las piezas y conexiones retiradas del vehículo deben ser reinstaladas de acuerdo con las especificaciones del fabricante del vehículo o sustituidas por piezas y herrajes suministrados por SW-MOTECH.

 **ATENCIÓN:** Asegure todas las roscas con fijador de roscas líquido de resistencia media, a menos que se especifique lo contrario.

 **PELIGRO:** Los pares de apriete no definidos por SW-MOTECH deben obtenerse del fabricante del vehículo o de un taller de motocicletas certificado.

COMPROBACIÓN FUNCIONAL: Después del montaje, asegúrese de que no haya piezas móviles bloqueadas y de que no se altere el funcionamiento del vehículo. Los cables y tubos no deben rozarse ni quedar pinzados.

 **ATENCIÓN:** Realice una comprobación exhaustiva del funcionamiento antes de iniciar la marcha. Tras los primeros 50 km y, después, con regularidad, compruebe el par de apriete de todas las conexiones y que el producto está firmemente sujeto. Los accesorios instalados pueden cambiar el comportamiento de conducción y la estabilidad del vehículo.



SW-MOTECH GmbH & Co. KG
Ernteweg 7-10
35282 Rauschenberg
Alemania



✉ info@sw-motech.com
🌐 www.sw-motech.com



Preste atención a los símbolos que figuran en la sección de MONTAJE y su significado. Cuando, en la sección de MONTAJE, aparecen las siglas OEM, se deberán seguir y aplicar las especificaciones del fabricante del vehículo.



Si tiene alguna pregunta, nuestro servicio de atención al cliente y nuestros distribuidores estarán encantados de prestarle ayuda. Encontrará nuestro número de teléfono y una lista de nuestros distribuidores en nuestra tienda online:

www.sw-motech.com



Usar fijador de roscas: Indica que una rosca debe recubrirse con fijador de roscas líquido. H (HIGH): resistencia alta; M (MEDIUM): resistencia media; L (LOW): resistencia baja.



Respete la información del par de apriete: Indica el par de apriete de una pieza especificada por SW-MOTECH o el fabricante del vehículo (OEM).

LISTA DE PIEZAS - LEE Y CONSERVA LAS INSTRUCCIONES DE MONTAJE!

2

1



FSC.01.529.900.01.02

 1/1

2



FSC.00.127.700

 1/1

3



M6 x 16; DIN 7991
SC.ST.06.016.01.7991.088

 1/1

4



M6; DIN 985
MU.ST.06.01.985.08

 1/1

5



KTM.54603069000

 1/1

6



M6 x 20; ISO 7380
SC.ST.06.020.01.73800.109

 1/1

7



Ø 12 / ø 6,4 / h 3
DB.00.120.064.003.01

 1/1

4

8



FSC.00.127.011.36

 1/1

9



M6 x 25; DIN 912
SC.ST.06.025.01.912.088

 1/1

10



FSC.00.127.022.02

 1/1

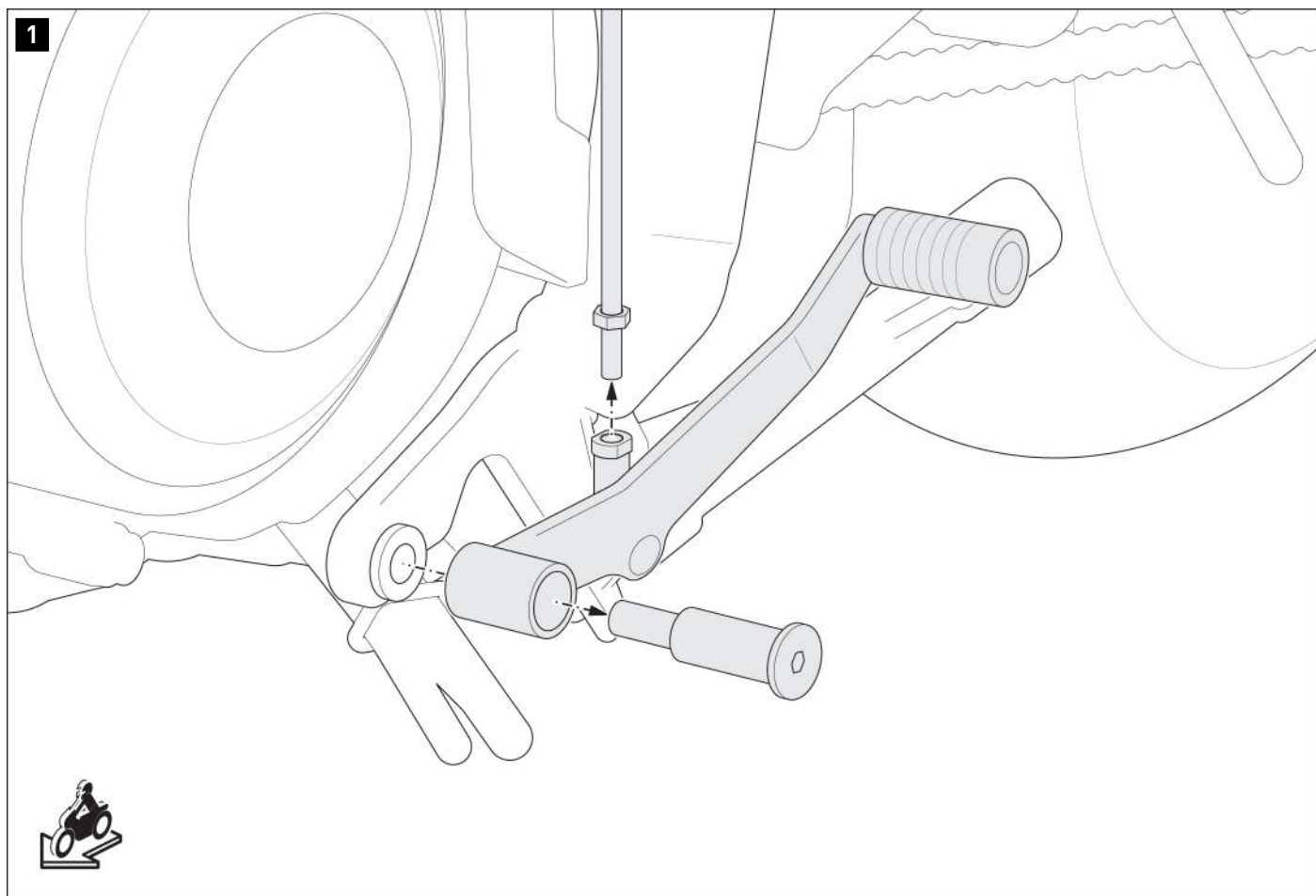

- ▲ **ATENCIÓN:** ¡Use siempre protección de ojos y manos!
- ▲ **ATENCIÓN:** ¡Utilice siempre herramientas adecuadas!

Afloje las piezas indicadas; retire la palanca de cambio original del vehículo.

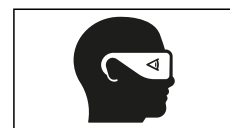

2

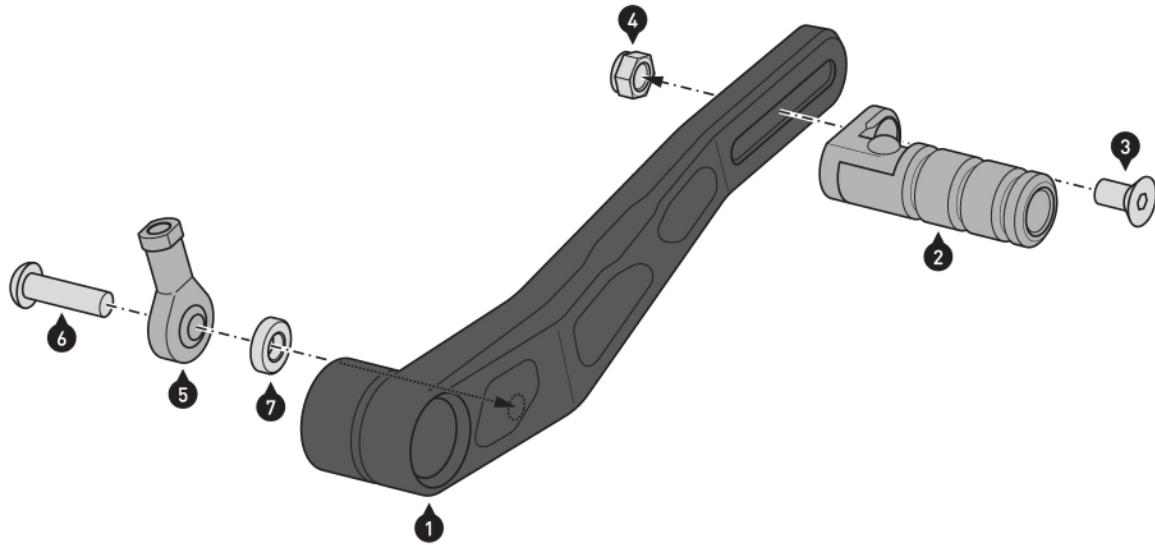

⚠ NOTA: El montaje de los componentes opcionales (8) - (10) se describe en el paso (4).

Atornille las piezas indicadas a la palanca de cambio (1).

⚠ ATENCIÓN: ¡Utilice fija tornillos líquido sólo en el tornillo (6)!

Apriete el tornillo (6) como se especifica en las instrucciones de montaje. No apriete el tornillo (3) todavía.

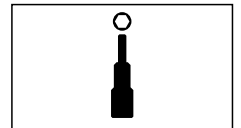
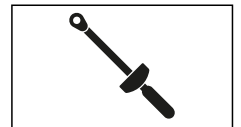

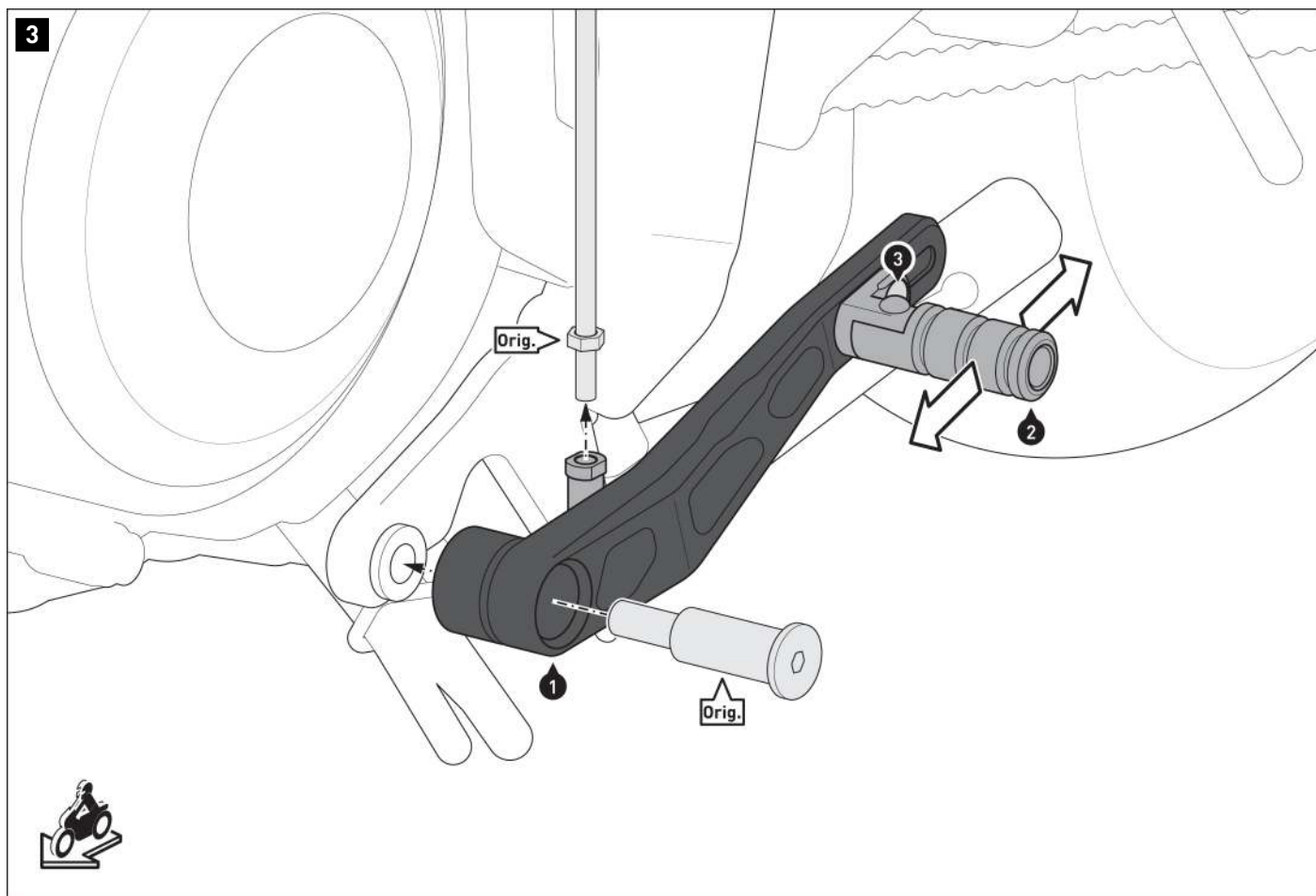

Atornille la varilla deflectora original (Orig.) a la palanca de cambios (1) (mín. 6 roscas); contrarreste la rosca con la tuerca.

Atornille la palanca de cambio (1) al vehículo con el tornillo original (Orig.).

▲ ATENCIÓN: ¡Utilice fijador de roscas líquido!

Apriete el tornillo original (Orig.) según las instrucciones del fabricante.

Ajuste la puntera (2) según sus hábitos de conducción.

A continuación, apriete el tornillo (3) como se especifica en las instrucciones de montaje.

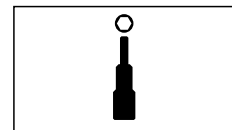
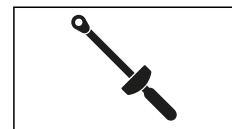

4

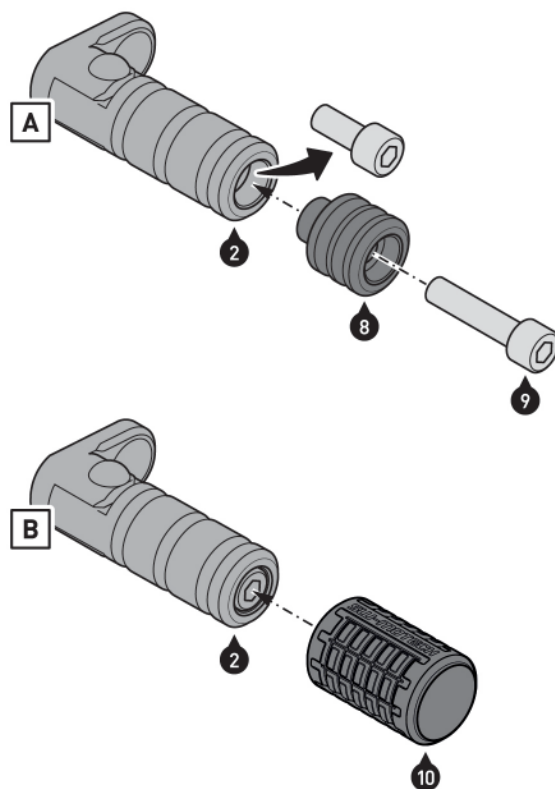

⚠ **NOTA:** Este paso de montaje es opcional.

Opción [A]: Retire el tornillo previamente montado en la puntera (2).
Atornille la extensión de la puntera (8) a la puntera (2).

⚠ **ATENCIÓN:** ¡Utilice fijador de roscas líquido!
Aprieta el tornillo (9) como se especifica en las instrucciones de montaje.

Opción [B]: Coloque el manguito de goma (10) sobre la puntera (2).
Asegúrese de que los anillos interiores del manguito de goma (10) estén bien colocados en los huecos de la puntera (2).

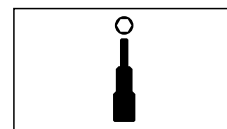
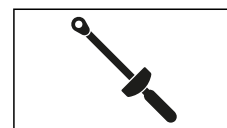

INDICACIONES ESPECÍFICAS DEL PRODUCTO

⚠ ATENCIÓN: ¡Este producto puede reducir la distancia al suelo y en curvas en caso de una inclinación extrema!

⚠ ATENCIÓN: ¡Después de instalar la palanca de cambio, asegúrese de que se garantice el libre movimiento de todos los componentes en el área de instalación! ¡Cambie todas las marchas y asegúrese de que el ajuste de la palanca de cambio se adapte a su ergonomía de conducción!

⚠ NOTA: *Deben respetarse las normas nacionales para la matriculación/uso del vehículo y las normas de inspección técnica vigentes. En caso de piezas con registro obligatorio, su organismo de inspección debe registrarlas tras el montaje en los documentos del vehículo.*

Numéro d'article: FSC.01.529.10000

Révision: 00 · Date: 06 - 2023

Sélecteur de vitesse

 ~ 0.75 h.FACILE     DIFFICILE

FRANÇAIS · Nous vous remercions d'avoir choisi ce produit haut de gamme de SW-MOTECH. Visitez notre boutique en ligne pour plus d'informations (par exemple affectation des modèles). Les documents nécessaires (par exemple ABE) y sont disponibles en téléchargement.

Veillez lire et prendre en compte toutes les instructions, les consignes de sécurité et les avertissements contenus dans ce manuel de montage avant de monter et d'utiliser le produit afin d'éviter toute blessure ou tout dommage. Veuillez conserver la notice d'utilisation pour référence.

Ce produit a été développé pour des véhicules en configuration d'usine. Nous ne sommes pas en mesure d'assurer la compatibilité avec les pièces de rechange originales ou les pièces de rechange d'autres fabricants.

La présente notice d'installation a été élaborée conformément à nos connaissances actuelles. Il n'existe aucun droit juridique à l'exactitude des informations qu'elle contient. Sous réserve d'erreurs et de fautes. Sous réserve de modifications techniques et conceptuelles. SW-MOTECH détient les droits d'auteur.

SYMBOLE D'AVERTISSEMENT DE SÉCURITÉ

⚠ Ce symbole d'avertissement est utilisé dans ces instructions de montage pour mettre en garde contre des dangers mortels, de blessures ou d'autres risques. Les mots DANGER, ATTENTION ou PRUDENCE sont utilisés avec ce symbole d'avertissement pour transmettre des consignes de sécurité et des informations importantes concernant le montage et l'utilisation de ce produit. Ces mots, associés au symbole d'avertissement de sécurité, signifient :

⚠ DANGER : signale une situation dangereuse pouvant entraîner la mort ou des blessures graves si elle n'est pas évitée !

⚠ ATTENTION : signale une situation dangereuse pouvant entraîner la mort ou des blessures graves si elle n'est pas évitée !

⚠ PRUDENCE : Indique une situation dangereuse susceptible d'entraîner des blessures de gravité réduite ou moyenne si elle se présente !

⚠ REMARQUE : Informations importantes, mais qui n'entraînent pas de risque de décès ou de blessure (dommages matériels uniquement).

REMARQUES GÉNÉRALES

⚠ ATTENTION : le montage et/ou l'entretien de ce produit nécessite des compétences techniques avancées, des outils appropriés et une bonne compréhension de l'utilisation des outils et des indications de réglage. Pour votre propre sécurité, SW-MOTECH recommande de confier le montage et/ou l'entretien à un atelier de réparation de deux-roues qualifié et certifié.

⚠ ATTENTION : si vous décidez de monter vous-même ce produit, lisez attentivement et intégralement les instructions de montage avant le montage et l'utilisation et suivez toutes les instructions afin d'éviter des blessures graves ou mortelles. Lors du montage et de l'utilisation, tenez également compte de toutes les informations pertinentes du manuel du véhicule. **SI VOUS NE COMPRENEZ PAS UNE PARTIE DE CE MANUEL D'INSTALLATION OU SI VOUS AVEZ BESOIN D'EXPLICATIONS CONCERNANT UNE INSTRUCTION, N'ESSAYEZ PAS D'INSTALLER CE PRODUIT SANS DEMANDER DE L'AIDE À SW-MOTECH !**

PRÉPARATION : Veuillez lire attentivement les instructions de montage et assurez-vous que tous les éléments de la liste de pièces sont présents.

⚠ PRUDENCE : veillez à ce que votre véhicule soit bien stable. Éteignez le moteur et retirez la clé de contact. Laissez refroidir le moteur/l'échappement si nécessaire. Débranchez la batterie lorsque vous travaillez sur le système électrique. Utilisez uniquement des outils appropriés et portez toujours des lunettes de protection et des gants pendant le montage et l'entretien. Faites-vous aider par une deuxième personne lors du montage et de l'entretien.

MONTAGE : Toutes les pièces et connexions retirées du véhicule doivent être réinstallées conformément aux instructions du fabricant du véhicule ou remplacées par des pièces et du matériel fournis par SW-MOTECH.

⚠ ATTENTION Sauf indication contraire, sécurisez tous les filetages avec du frein filet liquide de force moyenne.

⚠ DANGER : Les couples de serrage non définis par SW-MOTECH doivent être obtenus auprès du constructeur du véhicule ou d'un atelier de réparation de motos certifié.

CONTRÔLE DU FONCTIONNEMENT : Après le montage, assurez-vous qu'aucune pièce mobile n'est bloquée et que le fonctionnement du véhicule n'est pas perturbé. Les câbles et les tuyaux ne doivent pas frotter et/ou être coincés.

⚠ ATTENTION : Effectuez un contrôle de fonctionnement complet avant de commencer à rouler. Après les 50 premiers kilomètres, puis régulièrement, vérifiez le couple de serrage de tous les raccords et la bonne fixation du produit. Les accessoires montés peuvent modifier le comportement sur la route et la stabilité du véhicule.



SW-MOTECH GmbH & Co. KG
Ernteweg 7-10
35282 Rauschenberg
Allemagne



info@sw-motech.com
www.sw-motech.com



Vous trouverez les symboles et leur signification dans la section MONTAGE. Si le terme OEM apparaît dans la section MONTAGE, il faut respecter et appliquer les consignes du fabricant du véhicule.



Si vous avez des questions, notre service clientèle ainsi que nos distributeurs se tiennent à votre disposition. Vous trouverez notre numéro de téléphone ainsi que la liste de nos distributeurs sur notre boutique en ligne : www.sw-motech.com



Utilisez du frein filet : Indique qu'un filetage doit être enduit de frein filet liquide. H (HIGH) : haute résistance ; M (MEDIUM) : force moyenne ; L (LOW) : faible résistance.



Serrer en respectant les instructions de couple de serrage : indique le couple de serrage d'une pièce prescrit par SW-MOTECH ou par le fabricant du véhicule (OEM).

LISTE DES PIÈCES - LIRE ET CONSERVER LES INSTRUCTIONS DE MONTAGE!

2

1



FSC.01.529.900.01.02

 1/1

2



FSC.00.127.700

 1/1

3



M6 x 16 ; DIN 7991
SC.ST.06.016.01.7991.088

 1/1

4



M6; DIN 985
MU.ST.06.01.985.08

 1/1

5



KTM.54603069000

 1/1

6



M6 x 20; ISO 7380
SC.ST.06.020.01.73800.109

 1/1

7



Ø 12 / ø 6,4 / h 3
DB.00.120.064.003.01

 1/1

4

8



FSC.00.127.011.36

 1/1

9



M6 x 25; DIN 912
SC.ST.06.025.01.912.088

 1/1

10



FSC.00.127.022.02

 1/1

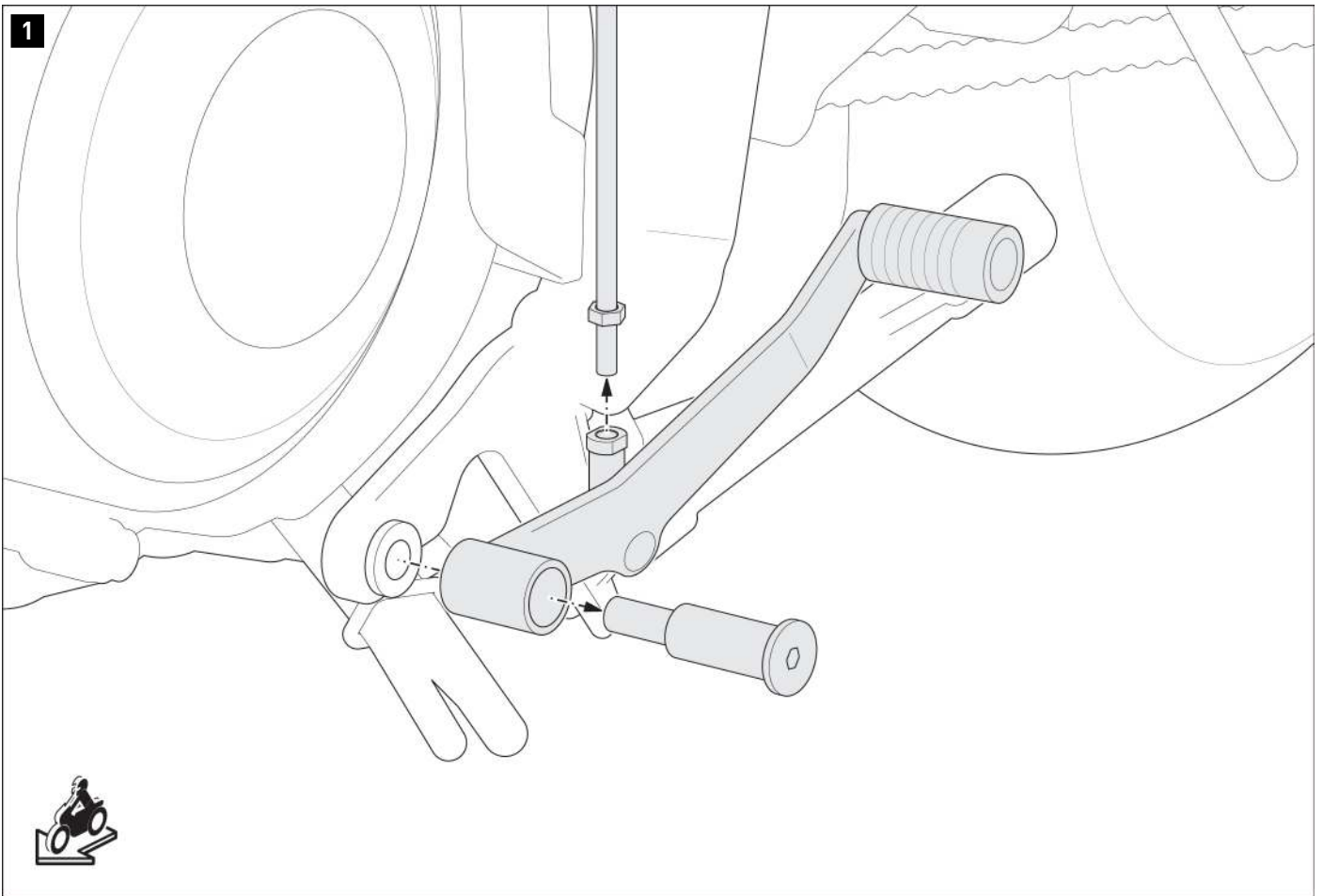

- ▲ ATTENTION : portez toujours des lunettes et des gants de protection !
- ▲ ATTENTION : utilisez toujours des outils adaptés !

Desserrez les pièces indiquées ; retirez le sélecteur de vitesse d'origine du véhicule.

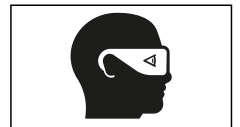

2

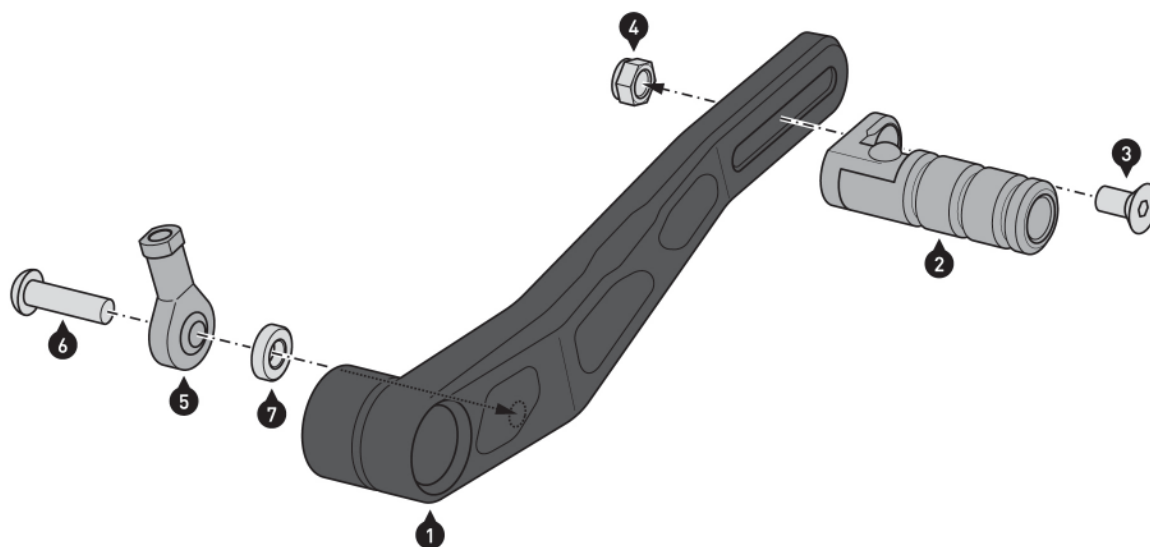

REMARQUE : L'assemblage des pièces optionnelles (8) - (10) est décrit à l'étape [4].

Vissez les pièces indiquées sur le sélecteur de vitesse (1).

AVERTISSEMENT : Utilisez du frein filet (uniquement sur les vis (6)) ! Serrez la vis (6) comme indiqué dans les instructions de montage. Ne serrez pas encore la vis (3).

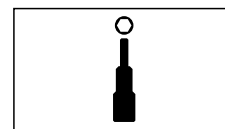
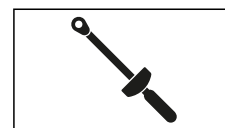
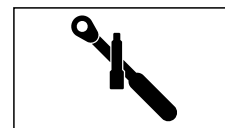

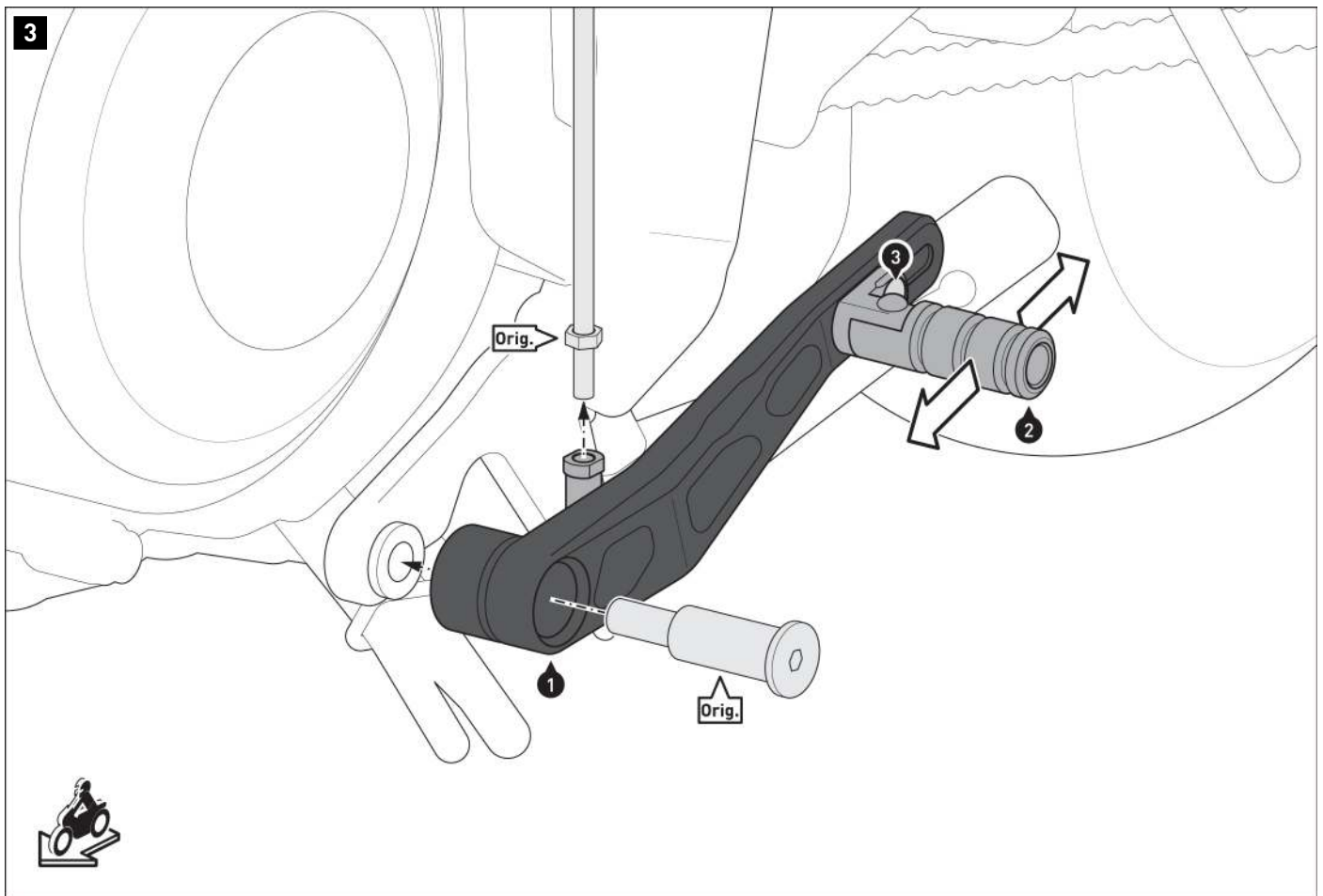

Visser la tige de sélecteur de vitesse d'origine (orig.) au sélecteur de vitesse (1) (effectuez au moins 6 tours de filetage) ; bloquez le filetage avec l'écrou.

Visser le sélecteur de vitesse (1) au véhicule à l'aide de la vis d'origine (orig.).

▲ ATTENTION : utilisez du frein filet liquide !

Serrez la vis d'origine (Orig.) selon les instructions du fabricant.

Ajustez le pas (2) en fonction de vos habitudes de conduite.
puis serrez la vis (3) comme indiqué dans les instructions de montage.

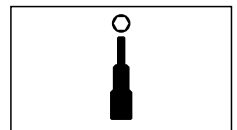
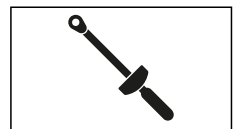

4

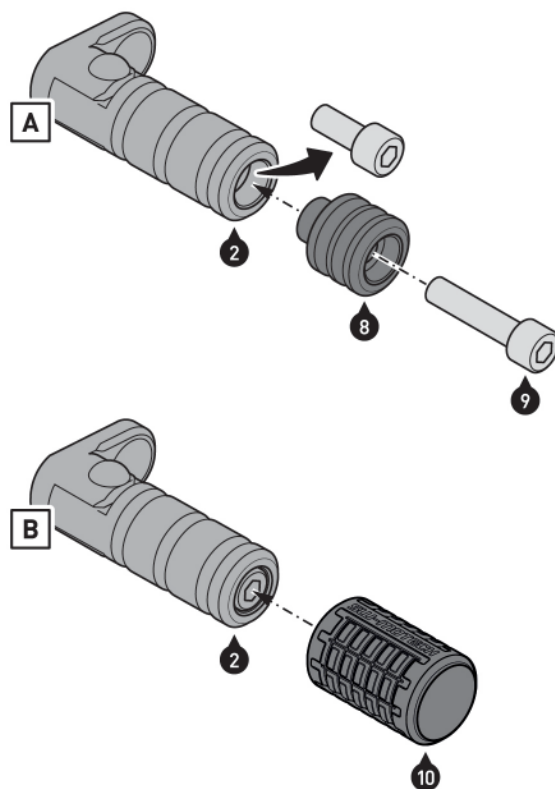

⚠ **REMARQUE** : cette étape de montage est facultative.

Option [A] : retirez la vis pré-montée dans la pédale (2).
Vissez l'extension de pédale (8) à la pédale (2).

⚠ **ATTENTION** : utilisez du frein filet liquide !

Serrez la vis (9) comme indiqué dans les instructions de montage.

Option [B] : placez le manchon en caoutchouc (10) sur la pédale (2).
Assurez-vous que les anneaux intérieurs du manchon en caoutchouc (10) soient bien placés dans les sillons de la pédale (2).

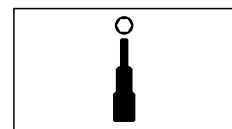
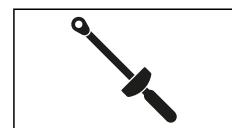

REMARQUES SPÉCIFIQUES AU PRODUIT

⚠ ATTENTION : Les virages et la garde au sol peuvent être limités par ce produit en cas d'inclinaison extrême !

⚠ ATTENTION : après avoir installé le sélecteur de vitesses, assurez-vous de la libre circulation de tous les composants dans la zone d'installation !
Passez toutes les vitesses et assurez-vous que le réglage du sélecteur de vitesses convient à l'ergonomie de votre conducteur !

⚠ REMARQUE : Respectez les réglementations spécifiques au pays pour l'immatriculation/l'utilisation de votre véhicule ou les réglementations TÜV applicables. Après le montage, faites inscrire les pièces soumises à immatriculation dans les papiers du véhicule par votre centre de contrôle.

Numero di articolo: **FSC.01.529.10000**Revisione: **00** · Data: **06 - 2023****Leva cambio** ~ 0.75 h.FACILE     DIFFICILE

ITALIANO -Grazie per aver scelto questo prodotto premium di SW-MOTECH. Visita il nostro negozio online per ulteriori informazioni (ad es. per la compatibilità con i vari modelli). I documenti richiesti (ad es. certificato di omologazione nazionale) possono essere scaricati qui.

Si prega di leggere attentamente le avvertenze di sicurezza e le istruzioni per il montaggio prima di montare e utilizzare il prodotto, al fine di evitare eventuali lesioni e danni. Conserva queste istruzioni per il montaggio come riferimento futuro.

Questo prodotto è stato sviluppato per veicoli in condizioni di fabbrica. La compatibilità con gli accessori originali o di altri produttori non può essere garantita.

Queste istruzioni per il montaggio sono state redatte in base alle nostre conoscenze attuali. Non sussistono pretese di correttezza giuridiche. Salvo errori ed omissioni. Ci riserviamo il diritto di apportare modifiche tecniche e di design. Copyright SW-MOTECH.

SIMBOLO DI SICUREZZA

 Questo simbolo di avvertenza è usato nelle presenti istruzioni di montaggio per segnalare pericoli mortali, rischio di lesioni o altri pericoli. Le parole "PERICOLO", "AVVERTENZA" O "ATTENZIONE" sono utilizzate con questo simbolo di avvertenza per trasmettere importanti istruzioni di sicurezza e informazioni relative al montaggio e all'uso di questo prodotto. Queste parole, utilizzate insieme al simbolo di avvertenza, significano:

▲ PERICOLO: indica una situazione di pericolo che, se non evitata, può causare morte o lesioni gravi!

▲ AVVERTENZA: indica una situazione di pericolo che, se non evitata, può causare morte o lesioni gravi!

▲ ATTENZIONE: indica una situazione di pericolo che, se non evitata, può provocare lesioni lievi o di entità moderata!

▲ AVVISO: indica informazioni importanti che non riguardano il rischio di morte o di lesioni (riguardano unicamente il rischio di danni materiali)!

INFORMAZIONI GENERALI

▲ AVVERTENZA: il montaggio e/o la manutenzione di questo prodotto richiedono competenze tecniche avanzate, strumenti adeguati e una buona conoscenza dell'uso della strumentazione e delle indicazioni relative alle coppie di serraggio. Per ragioni di sicurezza, SW-MOTECH raccomanda di far eseguire il montaggio e/o la manutenzione presso un'officina per motociclette qualificata e certificata.

▲ AVVERTENZA: se si decide di installare questo prodotto in autonomia, leggere attentamente le istruzioni per il montaggio prima del montaggio e dell'uso e seguire tutte le avvertenze per evitare lesioni gravi o mortali. Durante il montaggio e l'uso, seguire anche tutte le istruzioni pertinenti contenute nel manuale del veicolo. **SE NON SI COMPRENDONO TALI ISTRUZIONI, ANCHE SOLO IN PARTE, O SE SONO NECESSARI CHIARIMENTI, NON CERCARE DI MONTARE IL PRODOTTO IN AUTONOMIA SENZA CHIEDERE IL SUPPORTO DI SW-MOTECH!**

PREPARAZIONE: leggere attentamente le istruzioni per il montaggio e assicurarsi che siano disponibili tutti i componenti contenuti nella lista.

▲ ATTENZIONE: assicurarsi che il veicolo sia perfettamente fermo. Spegner il motore e togliere la chiave. Se necessario, lasciar raffreddare il motore/lo scarico. Scollegare la batteria quando si interviene sull'impianto elettrico. Usare esclusivamente strumenti idonei e indossare sempre occhiali e guanti protettivi durante le operazioni di montaggio e manutenzione. Chiedere aiuto a una seconda persona durante le fasi di montaggio e manutenzione.

MONTAGGIO: tutti i componenti e i collegamenti rimossi dal veicolo devono essere reinstallati secondo le specifiche del produttore del veicolo o sostituiti con componenti e attrezzatura forniti da SW-MOTECH.

▲ AVVERTENZA: fissare tutte le filettature con frenafili liquido a media resistenza, se non diversamente specificato.

▲ PERICOLO: le coppie di serraggio non definite da SW-MOTECH devono essere richieste al costruttore del veicolo o a un'officina certificata.

CONTROLLO DI FUNZIONALITÀ: dopo il montaggio accertarsi che non vi siano parti mobili bloccate e che il funzionamento del veicolo non sia compromesso. I cavi e i tubi flessibili non devono sfregare e/o essere schiacciati.

▲ AVVERTENZA: eseguire un controllo completo delle funzioni prima di mettersi alla guida. Controllare la coppia di serraggio di tutti i collegamenti e la tenuta del prodotto dopo i primi 50 km e in seguito regolarmente. Gli accessori montati possono modificare la maneggevolezza e la stabilità del veicolo.



SW-MOTECH GmbH & Co. KG
Ernteweg 7-10
35282 Rauschenberg
Germania



info@sw-motech.com
www.sw-motech.com



Consultare i simboli e il loro significato nella sezione MONTAGGIO. Se nella sezione montaggio compare la sigla OEM, è necessario rispettare e applicare le specifiche del produttore del veicolo.



Per qualsiasi domanda, non esitare a contattare il nostro servizio clienti o i nostri distributori. Il nostro numero di telefono e l'elenco dei nostri distributori sono disponibili nel nostro negozio online:

www.sw-motech.com























Usare un frenafiletto: indica che la filettatura deve essere rivestita con un frenafiletto liquido. H (ALTA): alta resistenza; M (MEDIA): media resistenza; L (BASSO): bassa resistenza.



Serraggio / rispetto delle specifiche sulla coppia di serraggio: indica la coppia di serraggio di un componente specificata da SW-MOTECH o dal produttore del veicolo (OEM).

ELENCO DELLE PARTI - LEGGI E CONSERVA LE ISTRUZIONI DI MONTAGGIO!

2	<p>1</p> 	<p>2</p> 	<p>3</p> 	<p>4</p> 	<p>5</p> 	<p>6</p> 
	<p>FSC.01.529.900.01.02</p> <p> 1/1</p>	<p>FSC.00.127.700</p> <p> 1/1</p>	<p>M6 x 16; DIN 7991 SC.ST.06.016.01.7991.088</p> <p> 1/1</p>	<p>M6; DIN 985 MU.ST.06.01.985.08</p> <p> 1/1</p>	<p>KTM.54603069000</p> <p> 1/1</p>	<p>M6 x 20; ISO 7380 SC.ST.06.020.01.73800.109</p> <p> 1/1</p>
	<p>7</p> 					
	<p>Ø 12 / ø 6,4 / h 3 DB.00.120.064.003.01</p> <p> 1/1</p>					
4	<p>8</p> 	<p>9</p> 	<p>10</p> 			
	<p>FSC.00.127.011.36</p> <p> 1/1</p>	<p>M6 x 25; DIN 912 SC.ST.06.025.01.912.088</p> <p> 1/1</p>	<p>FSC.00.127.022.02</p> <p> 1/1</p>			

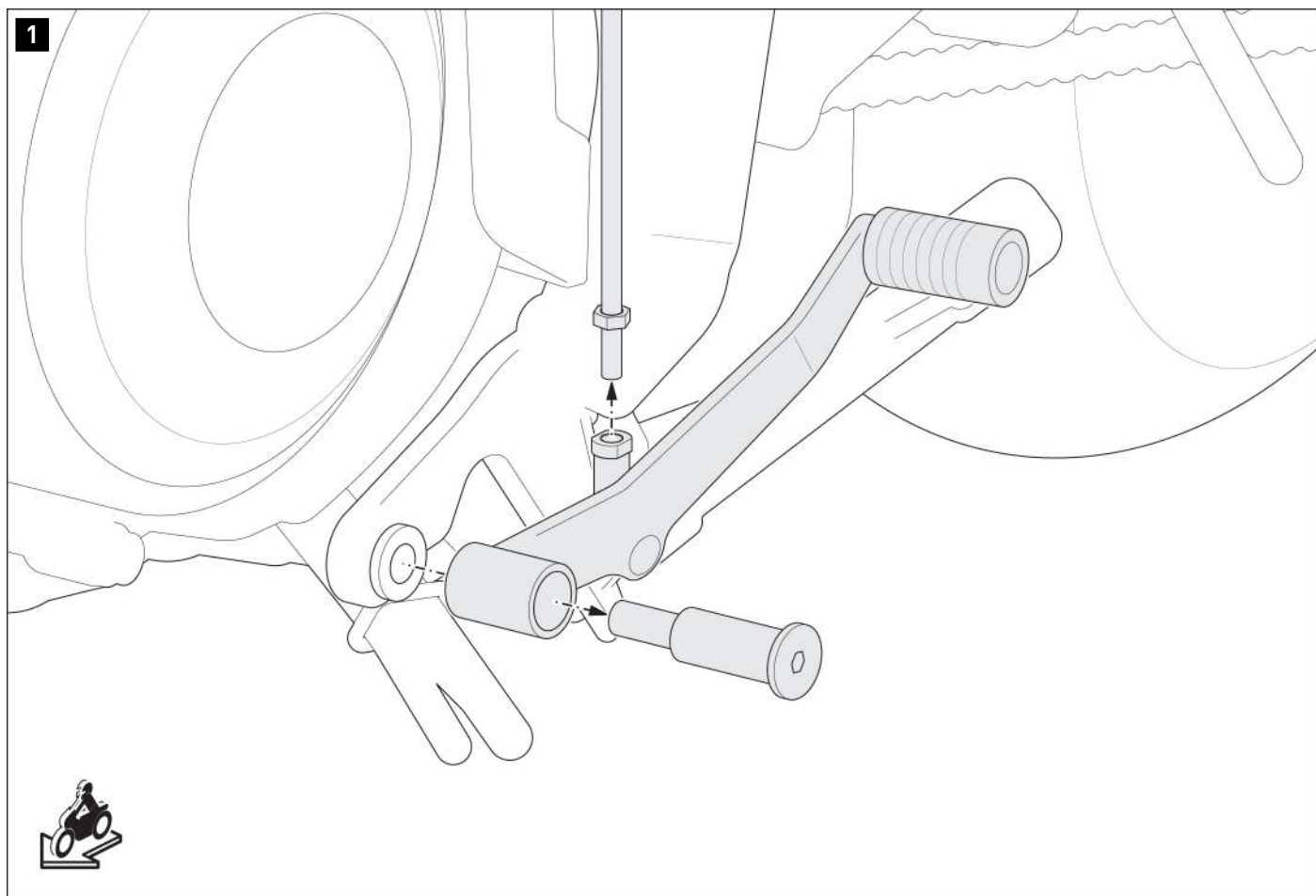

- ▲ **AVVERTENZA:** indossare sempre le protezioni per gli occhi e per le mani!
- ▲ **AVVERTENZA:** Utilizzare sempre strumenti adeguati!

Allentare le viti indicate e rimuovere la leva del cambio originale dal veicolo.

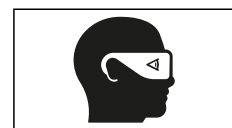

2

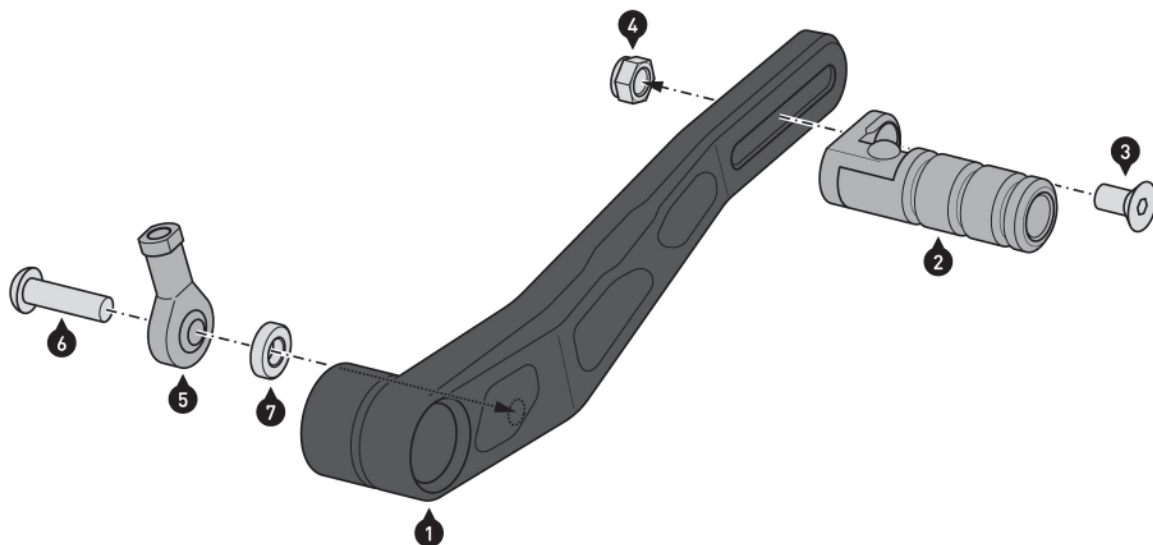

⚠ AVVISO: Il montaggio delle parti aggiuntive opzionali (8) - (10) è descritto nel passaggio [4].

Avvitare le parti indicate sulla leva del cambio (1).

⚠ AVVERTENZA: utilizzare un frenafilietti liquido (solo vite [6])!

Serrare la vite [6] come specificato nelle istruzioni per il montaggio. Non stringere ancora la vite [3].

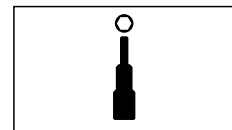
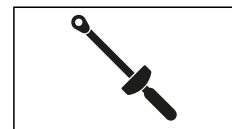

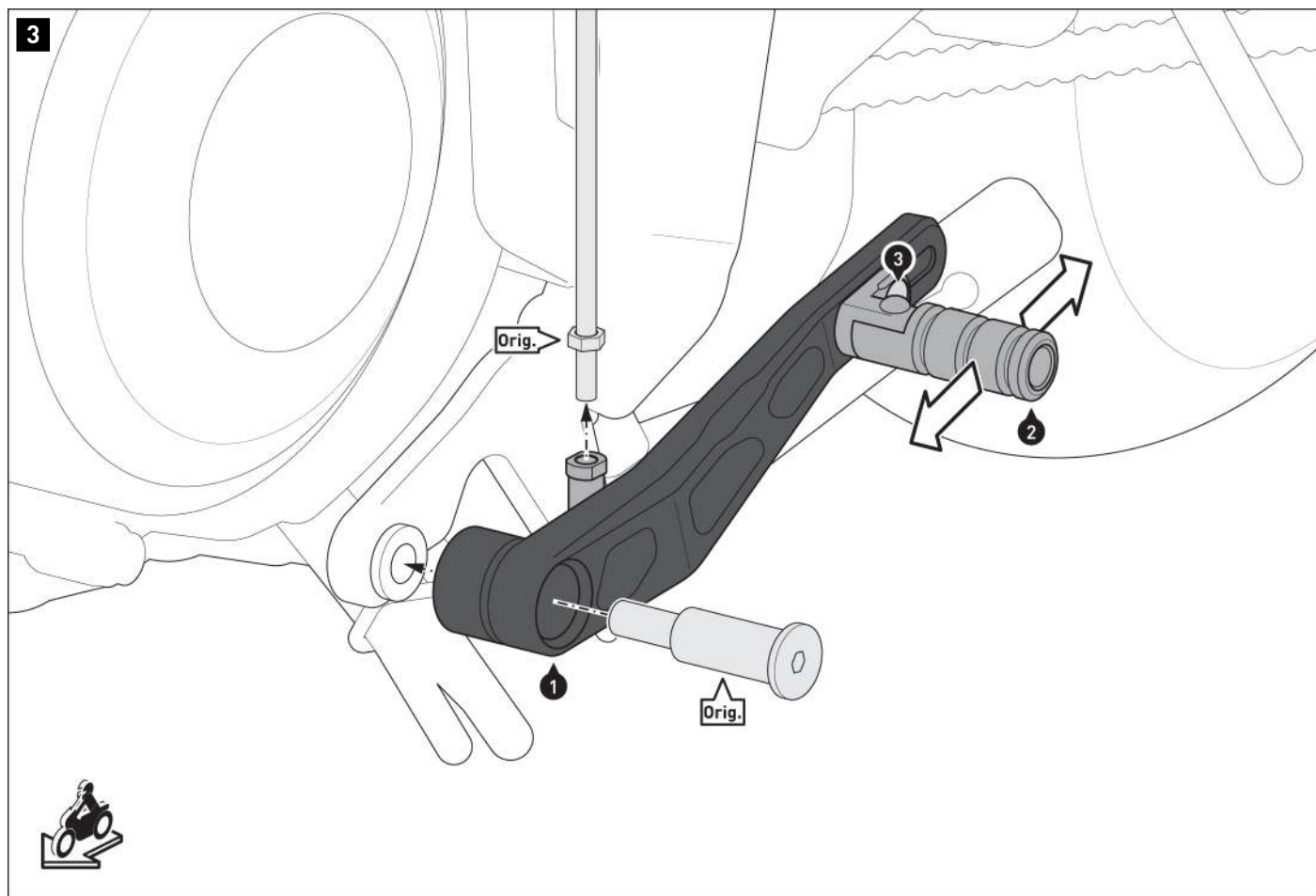

Avvitare la leva di rinvio originale [orig.] alla leva cambio (1) (min. 6 avvitamenti); bloccare la filettatura con il dado.

Avvitare la leva cambio (1) al veicolo utilizzando la vite originale (orig.).

▲ AVVERTENZA: Usare un frenafiletto liquido!

Stringere la vite originale (Orig.) secondo le istruzioni del produttore.

Regolare il gradino (2) in base alle proprie abitudini di guida, quindi serrare la vite (3) come specificato nelle istruzioni per il montaggio.

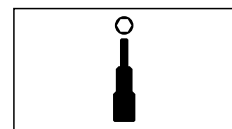
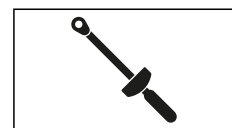

4

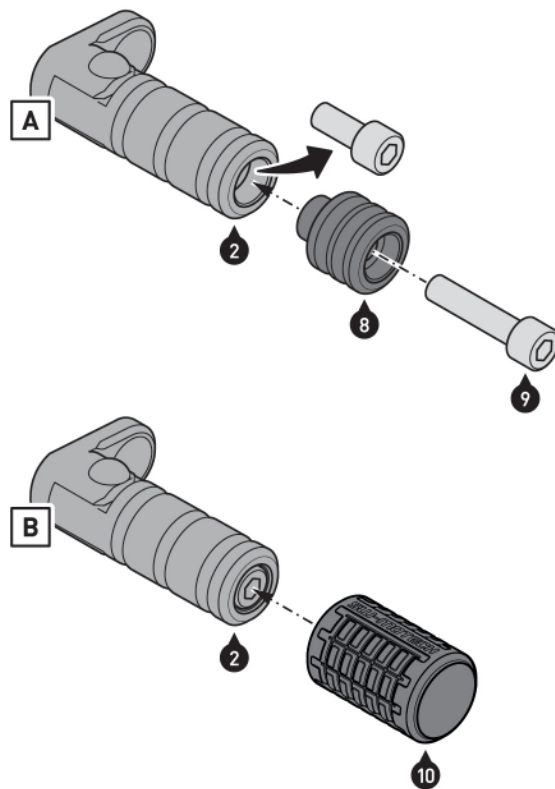

⚠ **AVVISO:** questo passaggio è opzionale.

Opzione [A]: rimuovere la vite premontata nel pedale (2).
Avvitare la prolunga del pedale (8) allo stesso (2).

⚠ **AVVERTENZA: Usare un frenafilietti liquido!**
Serrare la vite (9) come specificato nelle istruzioni per il montaggio.

Opzione [B]: applicare il manicotto in gomma (10) sul pedale(2).
Assicurarsi che gli anelli interni del manicotto in gomma (10) siano inseriti nelle cavità del pedale (2).



M 6 Nm

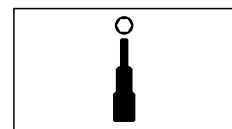
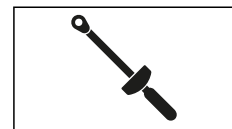

AVVERTENZE SPECIFICHE DEL PRODOTTO

▲ AVVERTENZA: in caso di inclinazione estrema, questo prodotto può limitare la tenuta in curva e in marcia su rettilineo!

▲ AVVERTENZA: Dopo aver installato il pedale cambio, assicurarsi che nella zona di installazione sia garantita la libera circolazione di tutti i componenti! Inserire tutte le marce e assicurarsi che il gioco del pedale cambio sia conforme alla propria ergonomia di guida!

▲ AVVISO : osservare le norme specifiche del Paese per l'immatricolazione/il funzionamento del veicolo o le norme TÜV applicabili. Dopo l'installazione, le parti soggette a omologazione devono essere registrate nei documenti del veicolo dall'autorità di controllo.