

ANBAUANLEITUNG

mounting instructions • instructions de montage • instrucciones de montaje • istruzioni di montaggio

HPR.00.666.20200/BK

beinhaltet • contains • contient • contiene • contiene

BHG-151-00-NP

HPR.00.220.20000/B

Barkbusters

www.barkbusters.net

FITTING INSTRUCTIONS for VPS Aluminium Backbone Fits 22mm (7/8 inch) Handlebars

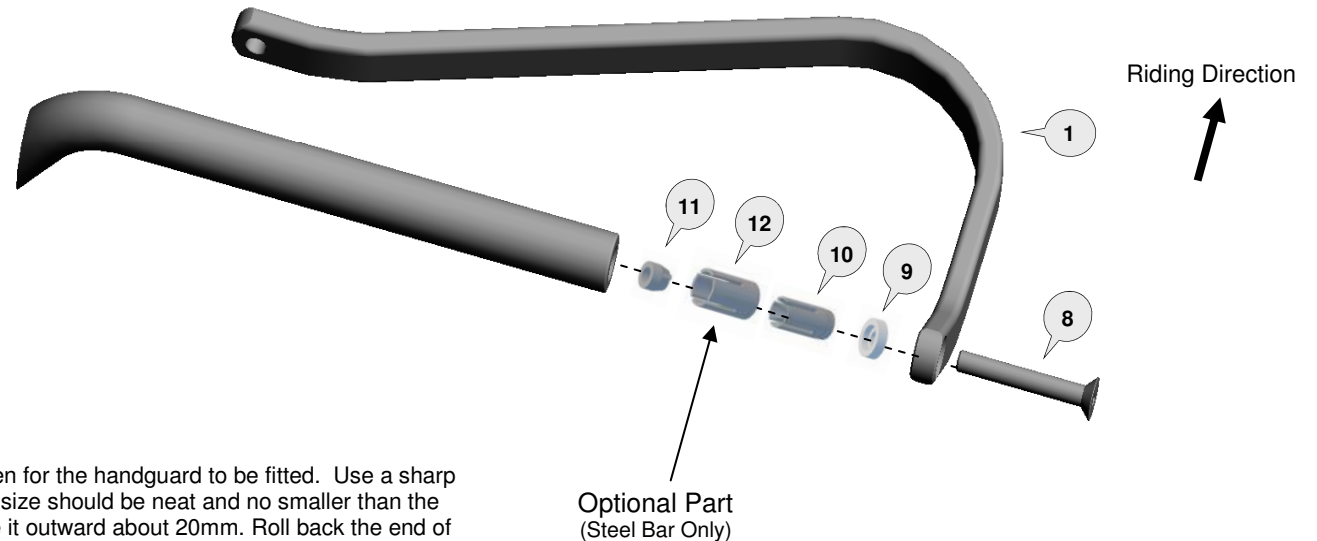
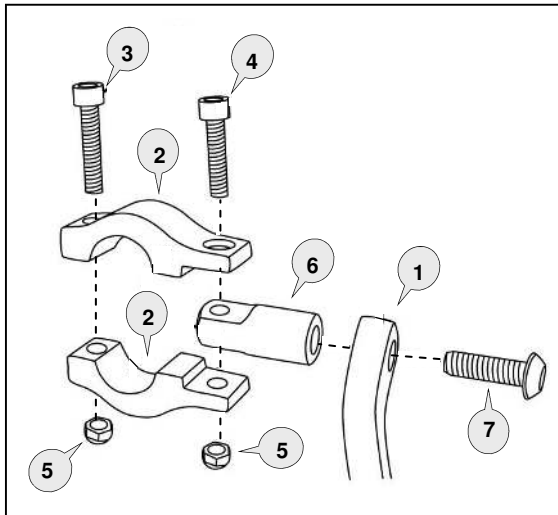

Preparation

If the handlebar grips are not open at the end they will need to be cut open for the handguard to be fitted. Use a sharp knife to cut a hole in the end of each handgrip. On the right side the hole size should be neat and no smaller than the inside diameter of the throttle tube. Loosen the throttle assembly to move it outward about 20mm. Roll back the end of the grip and use a hacksaw to carefully cut off the end cap of the plastic throttle tube. Do not remove more than 3mm and take care not to cut the underlying handlebar. Before refitting, remove any burrs that could restrict throttle movement.

Important Fitting Procedure

Loosely assemble the clamp to the handlebar as per diagram. Attach the handguard backbone with applicable parts to the handlebar end and also to the clamp connector (6).

Position backbone so it is horizontal when viewed from the side and tighten bolt (8).

The clamp bolts must be tightened in the following order:

Tighten bolt (7) through the aluminium bar (1) to the clamp connector (6) of the clamp assembly.

Tighten bolt (4) to solidly lock the swivel section (6) between the clamp saddles (2).

Tighten bolt (3) to secure the clamp assembly firmly to the handlebar.

Note: The clamp is designed to allow the nut on bolt (4) to pull into the recessed hole. This eliminates the need for a wrench after the bolt starts to tighten.

Some handlebars may have a solid insert welded into the handlebar end. In this situation we recommend drilling and

Installation Video available at www.barkbusters.net/media/videos.html

INS-BHG-151-00-NP

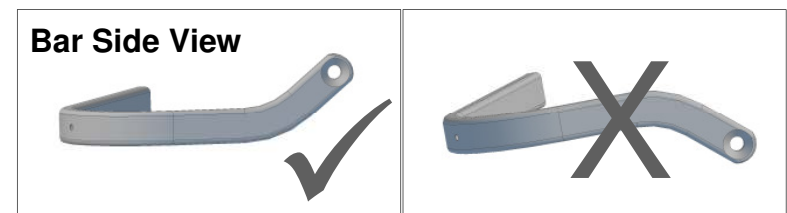

RIDEWORX

Phone: +61 (0)2 4271 8244
Email: info@barkbusters.net

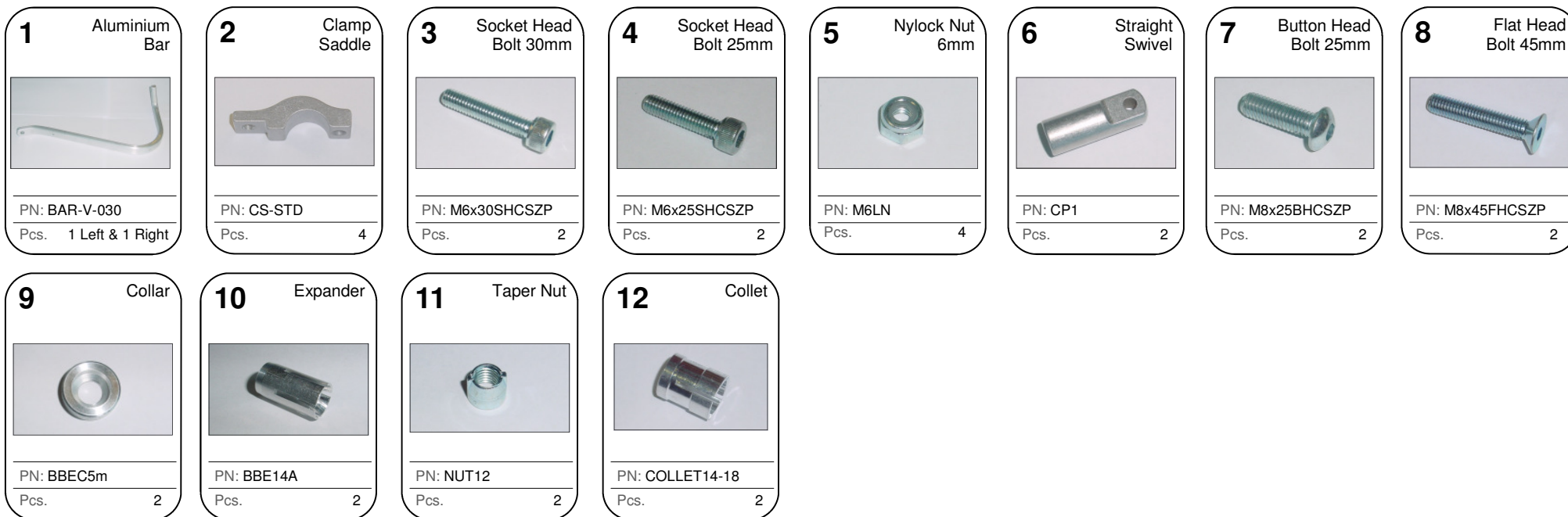

CAUTION:

Installation of the handguard is safety-relevant work and can be complicated. We recommend the installation be performed by a motorcycle service technician. Rideworx accepts no liability for damages caused by improper mounting. All screws, bolts and nuts, including all replacement hardware provided by Rideworx, should be tightened to the torque specified in the table. After the first 50km of riding check all screws, bolts and nuts are tightened to the correct torque. We recommend a medium strength liquid thread lock product on all fasteners.

Recommended Torque Settings	
M6	10 Nm (7.4 lbf ft)
M8	20 Nm (14.8 lbf ft)

WARNING:

It is important there is a working clearance (approx 3mm) between the throttle grip end and the handguard to ensure a free closing throttle. Check operation of all handlebar controls, specifically the throttle, front brake, kill switch and clutch to ensure they are operating correctly and are in accordance with the OEM specifications. Do not ride the motorcycle if any controls are not operating correctly. Check periodically that all bolts are tight.



Phone: +61 (0)2 4271 8244
 Email: info@barkbusters.net
 Web: www.barkbusters.net



Disclaimer:

A failure to follow these fitting instructions could cause serious injury, death or property damage. These handguards are intended solely for use with motorcycles/ATV/snowmobiles/scooters that have not been modified. They are not designed to prevent injury or death while riding or in an accident or crash. The user must ensure that all controls are free of the handguards every time that they ride. By installing and/or using this product you acknowledge that you accept these terms and have followed the fitting instructions.

KOBRA Handprotector-Schalen / KOBRA Handguard Shells

Die Artikelzuweisungen von diesem Produkt finden Sie auf unserer Website.
The application list for this product can be found on our website.

Montagehinweise

ACHTUNG: Die Montage dieses Produktes kann kompliziert sein und erfordert ein gutes technisches Verständnis. Wenn Sie unsicher sind, lassen Sie Montage und Wartung durch eine Fachwerkstatt durchführen. SW-MOTECH übernimmt keine Haftung für Schäden, die durch eine unsachgemäße Montage verursacht wurden.

ACHTUNG: Stellen Sie nach Montage der Handprotectoren sicher, dass alle Schalter- und Kontrolleinheiten, besonders der Gasgriff, Bremshebel, Notausschalter und die Kupplung, einwandfrei funktionieren und leicht zu bedienen sind. Achten Sie dabei auf die Übereinstimmung mit den OEM-Vorgaben. Fahren Sie nicht mit Ihrem Fahrzeug, wenn die Schalter- und Kontrolleinheiten nicht korrekt funktionieren oder zu bedienen sind. Stellen Sie des Weiteren sicher, dass der Lenker in beide Richtungen voll eingeschlagen werden kann. Überprüfen Sie regelmäßig (50 km) den festen Sitz aller Komponenten und Schrauben.

Technische Änderungen vorbehalten.
Irrtümer ausgenommen.

Mounting Instructions

ATTENTION: The assembly of this product can be complicated and requires a good technical understanding. If you are not sure of how to do this, have a specialty garage perform the mounting and service. SW-MOTECH accepts no liability for damages caused by improper installation.

ATTENTION: After the installation check all operations of all handlebar controls, specifically the throttle, front brake, kill switch and clutch, to ensure they are operating correctly and are in accordance with the OEM specifications. Do not ride the motorcycle if any controls are not operating correctly. Make sure the handlebar can fully turn in either direction. Check periodically (50 km) that all bolts are tight.

Subject to change. Not responsible for typos.

SW-MOTECH GmbH & Co. KG
Ernteweg 8/10
35282 Rauschenberg
Germany

Tel. +49 (0) 64 25/8 16 8-00
Fax +49 (0) 64 25/8 16 8-10

info@sw-motech.com
www.sw-motech.com

1 Handprotectoren-
Schale, LINKS
Handguard Shell,
LEFT



HPR.00.220.001/L

Anzahl/Pcs. 1

3 Befestigungsbügel
Saddle



HPR.00.220.005

Anzahl/Pcs. 2 (L/R)

2 Handprotectoren-
Schale, RECHTS
Handguard Shell,
RIGHT



HPR.00.220.001/R

Anzahl/Pcs. 1

4 Befestigungsbügel
Saddle



HPR.00.220.006

Anzahl/Pcs. 2 (L/R)

5 Gewindefurchende
Schraube
Self-Tapping Screw



M3,5 x 14 DIN 7981

Anzahl/Pcs. 8

Montage / Mounting

HINWEIS: Die Montage ist linksseitig dargestellt. Wiederholen Sie die Montage mit den entsprechenden Teilen am rechten Bügel analog zum linken Bügel.
Verschrauben Sie die Handprotektoren-Schalen (1) & (2) an den Bügeln (vor deren Montage am Fahrzeug), wie in der Zeichnung dargestellt.

ACHTUNG: Ziehen Sie die Schrauben vorsichtig handfest an (max. 2 Nm). Achten Sie unbedingt darauf, die Gewinde nicht zu überdrehen!

NOTE: Installation is shown for the left side. Repeat for right side with applicable parts.
Attach the handguard shells (1) & (2) to the backbones (before mounting the backbones to the vehicle), as shown in the drawing.

ATTENTION: Tighten the screws carefully by hand (max. 2 Nm). Do not overtighten the screws!

